

# TOTO

TOTO U.S.A., Inc. 1155 Southern Road Morrow, GA 30260  
Phone : (770) 282-8686

Warranty Registration and Inquiry  
For product warranty registration, TOTO U.S.A. Inc. recommends On-Line Warranty Registration. Please visit our web site <http://www.totousa.com>. If you have questions regarding warranty policy or coverage, please contact TOTO U.S.A. Inc., Customer Service Department, 1155 Southern Road, Morrow, GA 30260 (888) 295 - 8134 or (678) 466 - 1300 when calling from outside of U.S.A.

# TOTO

## Instruction Manual

## NEOREST WX



## NEOREST

- WX2** SN9548MX  
(CWT9548CEMFX)
- WX1** SN9538M  
(CWT9538CEMFG)



● You are advised to record the following information to allow quick service.

Date of purchase :	Name of shop :
Date : year month day	Tel : (     )

2023.7.10  
D07G94

Thank you for your recent purchase of this product.  
Please read the enclosed information to ensure the safe use of your product.  
Be sure to read this Instruction Manual before using your product and keep it in a safe place for future reference.

# Table of Contents

## Introduction

<b>Safety Precautions</b> .....	<b>4</b>
<b>Operational Precautions</b> .....	<b>9</b>
<b>Parts Names</b> .....	<b>12</b>
<b>Preparation</b> .....	<b>14</b>
Using the Product for the First Time.....	14
How to turn off the product .....	16

## Operation

<b>Basic Operations</b> .....	<b>17</b>
Mechanism of Auto Functions.....	17
Auto open / close.....	17
Auto bowl CLEAN.....	17
Deodorizer .....	17
Auto power deodorizer.....	17
Auto flushing.....	17
Auto wand CLEAN.....	18
Auto underseat CLEAN.....	18
Clean light function .....	18
Soft light .....	19
CLEAN indicator .....	19
Using the Remote Control .....	20
Stop.....	20
Rear washing.....	20
Rear soft washing.....	20
Front washing .....	20
Wide front washing .....	20
Water pressure adjustment .....	20
Wand position adjustment .....	20
Warm air drying .....	20
Oscillating washing.....	20
Pulsating washing.....	20
Full flush .....	21
Light flush .....	21
Wand CLEAN .....	21
Personal setting.....	21
Opening and closing the toilet lid .....	21
Opening and closing the toilet seat .....	21
Low battery warning LED.....	21
Menu, Return button .....	21
Temperature adjustment button .....	21
Power ON/OFF button .....	21
SELECT keys .....	21
Enter button.....	21
Display screen.....	21
About the Menu Screen .....	22

<b>Temperature Adjustment</b> .....	<b>24</b>
Warm water / Toilet seat / Drying .....	24
<b>Changing Settings</b> .....	<b>26</b>
Setting List .....	26
The energy saver features .....	28
How to Set .....	30
Auto energy saver.....	30
Auto energy saver+.....	30
Timer energy saver .....	31
Auto flushing.....	31
Auto flush delay .....	32
Auto flush lid closed.....	32
Auto open / close.....	34
Auto close delay .....	34
Auto open delay.....	35
Seat/lid .....	36
Auto wand CLEAN.....	36
Auto bowl CLEAN.....	37
Auto underseat CLEAN.....	37
Deodorizer .....	38
Auto power deodorizer.....	38
Night light .....	39
Soft light .....	40
Bowl light.....	40
CLEAN indicator .....	41
Language settings .....	41
Beep sound .....	42
Pressure/position setting .....	42
Personal setting.....	43
Registering Personal Settings.....	44
Sensor detection range.....	45

## Maintenance

<b>Maintenance</b> .....	<b>46</b>
Before Maintenance .....	46
Top Unit.....	47
Bowl Unit.....	48
Manual Spray .....	49
Wand.....	50
Wand cleaning .....	50
Deodorizing Filter .....	51
Drain Plug With Water Supply Filter.....	52

## Reference

<b>What to Do?</b> .....	<b>53</b>
If there is no water due to a power outage or water failure.....	53
If a power outage occurs.....	53
If a water outage occurs .....	53
If you cannot operate with the remote control .....	53
Replacing the batteries .....	53
Freeze Damage Prevention .....	54
Long Periods of Disuse.....	55
How to drain the water.....	55
Resupplying the Water.....	56
How to remove the operation guide .....	57
<b>Troubleshooting</b> .....	<b>58</b>
Please check first .....	58
Rear Washing, Front Washing and Wand. ....	59
Warm air drying .....	60
Flushing .....	60
Toilet Seat and Toilet Lid (Auto open / close)...	62
Toilet Seat and Toilet Lid.....	63
Auto flush lid closed.....	63
Energy Saver.....	64
Deodorizer.....	64
Auto bowl CLEAN, Auto underseat CLEAN....	65
Lights .....	65
Others .....	66
<b>Specifications</b> .....	<b>68</b>
<b>Limited Warranty</b> .....	<b>69</b>

## The available functions vary according to the model no.

Functions	Model No.*1	
	SN9548MX	SN9538M
Clean light function	●	—

\*1 The model no. is on the toilet lid label. (→Page 12)

# Safety Precautions

## IMPORTANT SAFEGUARDS

### READ ALL INSTRUCTIONS BEFORE USING

#### Symbols and Meanings

 **WARNING** May result in death or serious injury.

 **CAUTION** May result in injury or property damage.

### WARNING

#### Never disassemble, repair or alter.

Doing so may cause fire, electrical shock, overheating, short circuit or breakdown.

#### Do not use the product if a malfunction occurs.

In case of breakdown or other problems, be sure to cut off power, by flipping the power switch to OFF or switching the breaker on the distribution board to OFF, etc.

Close the water shutoff valve to stop water supply.

Possible malfunctions:

- Water is leaking from a pipe or the top unit.
- The product is cracked or broken.
- The product makes a strange noise or emits a strange odor.
- The product emits smoke.
- The product is abnormally hot.
- The bowl unit is clogged.
- The toilet seat cushion is out of place.

Continued use after malfunction could cause a fire, electrical shock, heat, short circuit, injury or water damage.

#### Do not use other water than allowed by the laws and ordinances of the region of use. Only Use potable water.

#### Do not use seawater or recycled water.

Doing so may cause irritation to the skin and malfunction.

#### Keep cigarettes and other open flames away from the product.

Failure to do so may cause fire.

#### If the power cord is damaged, avoid danger by having the manufacturer's repair department or equivalent specialist replace it.

#### Turn the power OFF before maintenance or inspection.\*1

Failure to do so may cause electrical shock or malfunction.

#### Refrain from sitting on the seat for long periods.

It may cause low-temperature burns.

To prevent the following persons from getting a moderate temperature burn during use, other person should turn off the toilet seat heater and set the dryer temperature to "Low".

- Young children, the aged and other users unable to set the temperature appropriately themselves.
- The ill, physically disabled and others who do not have freedom of movement.
- Those using any medicines that cause drowsiness (sleeping or cold medicine), those who have been drinking heavily, anyone severely fatigued and anyone else liable to fall asleep.

#### When leaking battery fluid adheres to your body or clothes, wash it away with clean water.

The fluid may damage your eyes or skin.

#### Do not install the product on moving vehicles such as wheeled vehicles or boats.

Doing so may cause fire, electric shock, short circuit or malfunction.

The toilet seat, toilet lid, top unit, or other parts may come loose and fall off, resulting in injury.

### WARNING

Do not use any power supply other than the one specified.

AC 120 V, 60 Hz

Doing so may cause fire or excessive heat.

This is an electrical product. Do not install it anywhere water is likely to get on the product or anywhere with humidity high enough that water is likely to form on the surface of this product. When using the product in a bathroom, install a fan or ventilation port and ensure good air flow through the bathroom.

Failure to do so may cause fire or electrical shock.

#### Always connect the product to the cold water supply.

Connecting to hot water supply may result in burns and equipment damage.

#### Do not stick a finger or anything else into the warm air outlet.

#### Do not place anything on the warm air outlet or drape clothes over it.

Doing so may cause burns, electrical shock or malfunction.

#### Do not look directly at Clean Light\*2.

Doing so may cause eye or skin irritation.

There are no user replaceable parts. Shall be serviced by qualified personnel only.

Preliminary studies in females suggest that overuse of continuous spraying can increase the possibility of vaginal mucosa drying and potential reduction in desirable microbial organisms. Although these studies have not been validated, please consult your healthcare provider for concerns regarding whether these circumstances may apply to you.

More importantly, if you are an individual suffering from any immune deficiency as a result of disease, chemotherapy, or other medical condition compromising the immune system you should consult your healthcare provider before use of this product.

\*1 How to turn off the product (→Page 16)

\*2 For units with the "Clean light function" function only.

# Safety Precautions

## CAUTION

### Do not use the product if the top unit is unstable.

Doing so may cause the top unit to come loose and fall, resulting in injury.

### If the product is damaged, do not touch the damaged section.

Doing so may cause electrical shock or injury.  
Replace it immediately.

### Do not apply strong force, mechanical shock, step on or stand on the toilet seat, toilet lid or top unit. Also do not place any heavy object on the toilet seat, toilet lid or top unit.

Doing so may cause cracking or cause the top unit to come loose and fall, resulting in injury.  
Doing so may damage the product and cause injury or water damage.

### When maintaining the plastic parts (top unit etc.) or the water supply hose, use a pH neutral kitchen detergent diluted with water. Do not use any of the following.

#### Toilet cleaner, household cleaner, benzene, paint thinner, powdered cleanser or nylon scrubbing brush.

These items may damage or crack the plastic and cause injury or malfunction.  
These items could damage the water supply hose and cause a water leak.

### To prevent a sudden water leak, do not remove the drain plug with water supply filter when the shutoff valve is open.

Doing so will cause water to spurt out.  
(→Refer to Page 52 for instructions on cleaning the Drain Plug With Water Supply Filter.)

### Do not fold or crush the water supply hose; do not damage by cutting with a sharp object.

Doing so may cause water leaks.

### Do not pour hot water into the toilet.

Doing so may result in damage to the toilet, injury or water damage.

### Keep the bowl filled with water.

Failure to do so may cause sewer gas, chlorine gas, or hydrogen sulfide to corrode facilities and equipment.

### Do not flush anything other than bodily waste and toilet paper. Also, do not flush too much toilet paper. Do not flush the bowl unit if it is clogged.

Doing so may clog the toilet, causing waste water overflow, and water damage.

### Always flush, even after just urinating.

Failure to do so may clog the toilet, causing waste water overflow and water damage or inadequate flushing of the bowl unit.

### Wipe condensation on the bowl unit, tank, water supply pipe and shutoff valve with a dry cloth.

Condensation may cause staining and corrosion of the floor. Ventilate the restroom to prevent condensation.

### Wipe any urine, condensation, cleaner, water, etc. that has gotten on the floor with a well-wrung mop or cloth.

Failure to do so may cause staining and corrosion of the floor.

### If a water leak should occur, always close the shutoff valve.

### When the ambient temperature is likely to drop to 32 °F (0 °C) or lower, prevent damage to the pipes and hoses due to freezing.

Frozen water pipes could cause the top unit and the pipes to break, resulting in a water leak.  
Regulate the room temperature to prevent the pipes and hoses from freezing during cold months.

## CAUTION

### When not using the product for a long time, close the shutoff valve, drain the water from the top unit and water supply hose, and then turn the power OFF.\*1

When using the product again, allow the product to refill with water first. Otherwise, the water in the tank might become contaminated and cause skin inflammation or other problems. (→Refer to Page 56 for instructions on Resupplying the Water.)  
Leaving the power on may cause fire or heat.

### When installing the drain plug with water supply filter, make sure that it is securely tightened in its proper position.

Failure to securely tighten it may cause a water leak.

### If the bowl is clogged, turn the power OFF\*1 and remove the clog.

If the auto flush were allowed to function, it would make the wastewater in the bowl unit overflow and may result in water damage.  
Use commercially available tools that are made for unclogging the bowl unit to remove the clogging.

### Make sure of the plus and minus signs on the batteries before inserting them.

#### Remove depleted batteries immediately.

When replacing the batteries:

- Replace both batteries with new ones.
- Use the same brand for both new batteries (any brand available).

Failure to do so may cause the batteries to leak fluid, generate heat, rupture, or ignite.

### When the product is supposed not to be used for long time, remove the batteries from the remote control.

Failure to do so may cause the batteries to leak fluid.

\*1 How to turn off the product (→Page 16)



# Safety Precautions

## DANGER

### To reduce the risk of electrocution:

1. Do not use while bathing.
2. Do not place or store the product where it can fall or be pulled into a tub or sink.
3. Do not place in or drop into water or other liquid.
4. Do not reach for the product when it has fallen into water. Unplug it immediately.

## WARNING

### To reduce the risk of burns, electrocution, fire or injury to persons:

1. Close supervision is necessary when this product is used by, on, or near children or invalids.
2. Use this product only for its intended use as described in this manual. Do not use attachments not recommended by the manufacturer.
3. Never operate this product if it has a damaged cord or plug, is not working properly, has been dropped or damaged, or has been dropped in water. Return the product to a service center for examination and repair.
4. Keep the cord away from heated surfaces.
5. Never block the air openings on the product or place it on a soft surface, such as a bed or couch, where the air openings may be blocked. Keep the air openings free of lint, hair, and other similar items.
6. Never use while sleepy or drowsy.
7. Never drop or insert any object into any opening or hose.
8. Do not use outdoors. Do not operate where aerosol (spray) products are being used or where oxygen is being administered.
9. Connect this product to a properly grounded outlet only.  
See "Grounding Instructions" in below.
10. The tank should be filled with water only.

- Servicing should be performed by an authorized service representative.
- This product is for household use.

# Grounding Instructions

This product should be grounded. In the event of an electrical short circuit, grounding reduces the risk of electric shock by providing an escape wire for the electrical current.

This product is equipped with a cord having a grounding wire with a grounding plug.

The plug must be plugged into an outlet that is properly installed and grounded.

 **DANGER** - Improper use of the grounding plug can result in a risk of electric shock.

If repair or replacement of the cord or plug is necessary, do not connect the grounding wire to either flat-head terminal.

Check with a qualified electrician or serviceman if the grounding wire instructions are not completely understood, or if in doubt as to whether the product is properly grounded.

**SAVE THESE INSTRUCTIONS**

# Operational Precautions

## For prevention of damage

Wipe plastic areas such as the top unit and remote control with a soft cloth tightly wrung out with water.

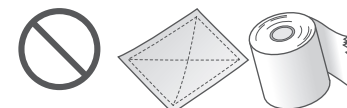

Dry cloth or tissue

## Do not lean against the toilet lid.



## For prevention of malfunctions and failures

Turn the power OFF if there is a risk for lightning strike.\*1

A toilet seat cover or a toilet lid cover cannot be used. Otherwise, the seat sensor may not detect properly. Additionally, the toilet seat and lid may not open or close properly.



Covers

Do not urinate on the top unit, toilet seat or wand. Doing so may cause a failure or discoloration.

Do not apply strong forces to the control panel of the remote control.

When using a toilet cleaner to clean the toilet, rinse it off within 3 minutes and leave the toilet seat and toilet lid open.

If vapor from a toilet cleaner enters the top unit, it may cause a malfunction.

► Wipe off any cleaner that remains on the bowl unit.

**Note:** If "Auto flush lid closed" (→ Pages 32, 33) is turned ON and you use the remote control to flush the bowl unit, the toilet seat and lid close before flushing the bowl unit. After the bowl unit has been flushed, open the toilet seat and lid.

Do not expose to direct sunlight.

Doing so may cause changes in color, irregular heated seat temperature or remote control malfunction.

Use radios, etc. away from the product.

The product could cause interference with the radio signal.

If you use a booster seat for infants or a soft highchair, remove it after use.

Keeping it installed may prevent some of the functions from being used.

Do not apply force to the remote control.

This cause malfunction.

► To prevent the remote control from being dropped, set it in the hanger when you are not using it. Be careful not to expose it to water.

Do not place anything on the toilet seat, and do not press them with hands.

Doing so may activate the seat sensor, causing the floor to get wet if buttons on the remote control are touched and warm water comes out from the wand.

\*1 How to turn off the product (→Page 16)

# Operational Precautions

## About the built-in body sensor

The body sensor detects human movement. The toilet lid opening or "Auto bowl CLEAN" operation may be triggered by someone outside the bathroom as the sensor detects human movement through the door or wall in front of the top unit.

The sensor may not detect properly depending on the bathroom layout, resulting in the toilet lid not opening automatically.

For someone small such as a child, the body sensor may not detect properly, resulting in the toilet lid not opening automatically.

When you are using the toilet in standing position, the length of time it takes for "Auto flushing" to complete or for the toilet lid or seat to close automatically depends on the bathroom layout, etc.

## About the built-in seat sensor

When you sit on the toilet seat, the seat sensor turns ON, enabling you to use various features. The deodorizer starts when the seat sensor makes a detection.

A label indicating the position of the seat sensor is attached to the seat.

Detection by the sensor may be difficult when the toilet is used by someone small, such as a child, depending on how the person sits.

- ▶ Sit on the seat with the label as a guide.  
(The label can be peeled off).

### Sit so your skin is in direct contact with the seat sensor.

The seat sensor may not detect properly if there is a seat cover or clothing.

If you use the booster seat for infants, the seat sensor may not detect properly, resulting in the toilet lid closing automatically during use.

- ▶ Turn "Auto open / close" OFF before use.

Water droplets collecting on the seat sensor may cause the top unit to malfunction.

- ▶ Be sure to wipe off any water droplets on the sensor.  
Do not use items that cause damage, such as toilet paper. (→Page 47)

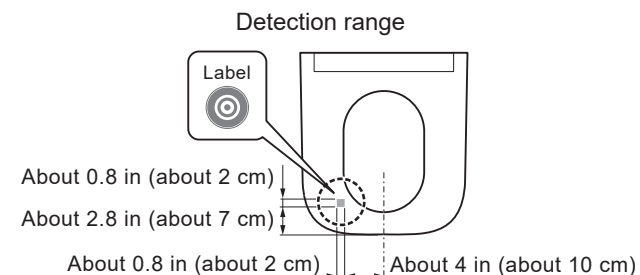

## Remote Control and Body Sensor Compliance

### FEDERAL COMMUNICATIONS COMMISSION (FCC) INTERFERENCE STATEMENT

This equipment has been tested and found to comply with the limits for a Class B digital device, pursuant to part 15 of the FCC Rules. These limits are designed to provide reasonable protection against harmful interference in a residential installation. This equipment generates, uses and can radiate radio frequency energy and, if not installed and used in accordance with the instructions, may cause harmful interference to radio communications.

However, there is no guarantee that interference will not occur in a particular installation.

If this equipment does cause harmful interference to radio or television reception, which can be determined by turning the equipment off and on, the user is encouraged to try to correct the interference by one or more of the following measures:

- Reorient or relocate the receiving antenna.
- Increase the separation between the equipment and receiver.
- Connect the equipment into an outlet on a circuit different from that to which the receiver is connected.
- Consult the dealer or an experienced radio/TV technician for help.

#### CAUTION:

Any changes or modifications not expressly approved by the grantee of this device could void the user's authority to operate the equipment.

This device complies with part 15 of the FCC Rules.

Operation is subject to the following two conditions:

- (1) this device may not cause harmful interference, and
- (2) this device must accept any interference received, including interference that may cause undesired operation.

#### RF exposure warning

This equipment complies with FCC RF exposure limits set forth for an uncontrolled environment.

This equipment must not be co-located or operating in conjunction with any other antenna or transmitter.

### Canada, Industry Canada (IC) Notices

This device complies with Industry Canada's licence-exempt RSSs.

Operation is subject to the following two conditions:

- (1) This device may not cause interference; and
- (2) This device must accept any interference, including interference that may cause undesired operation of the device.

#### Radio Frequency (RF) Exposure Information

The radiated output power of the Wireless Device is below the Industry Canada (IC) radio frequency exposure limits. The Wireless Device should be used in such a manner such that the potential for human contact during normal operation is minimized.

This device has also been evaluated and shown compliant with the IC RF Exposure limits under portable exposure conditions.

(antennas are less than 8 inch (20 cm) of a person's body).

# Parts Names

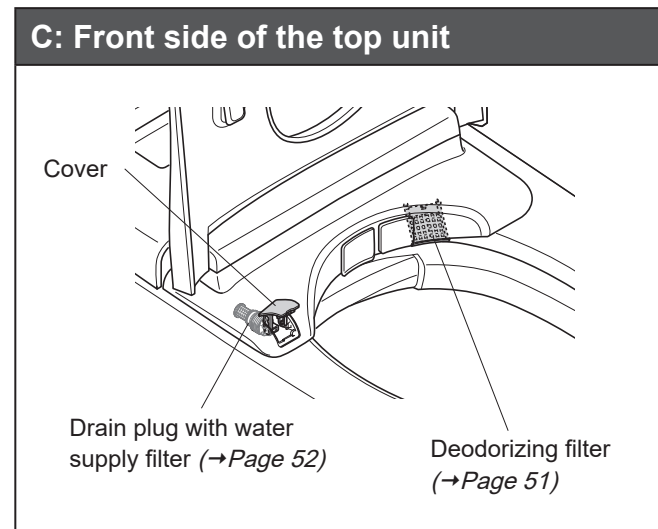
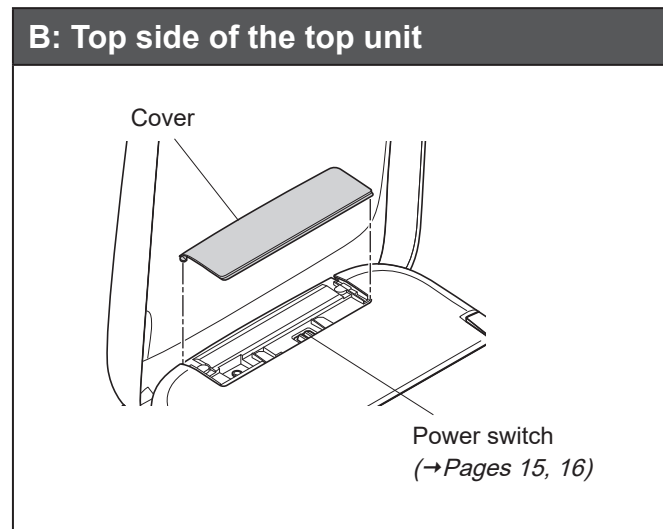
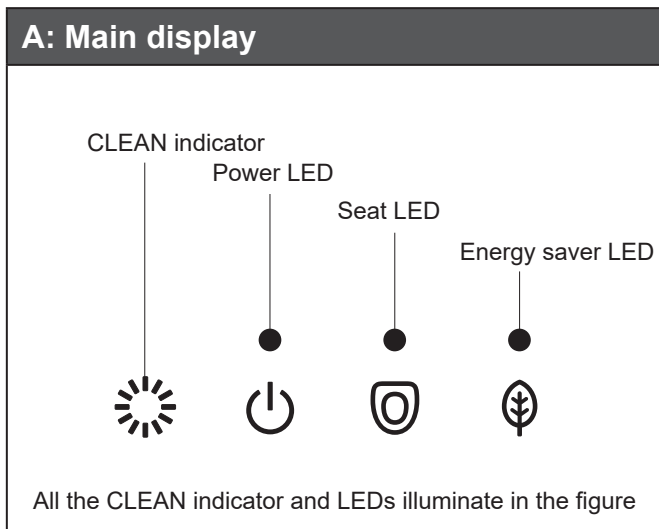
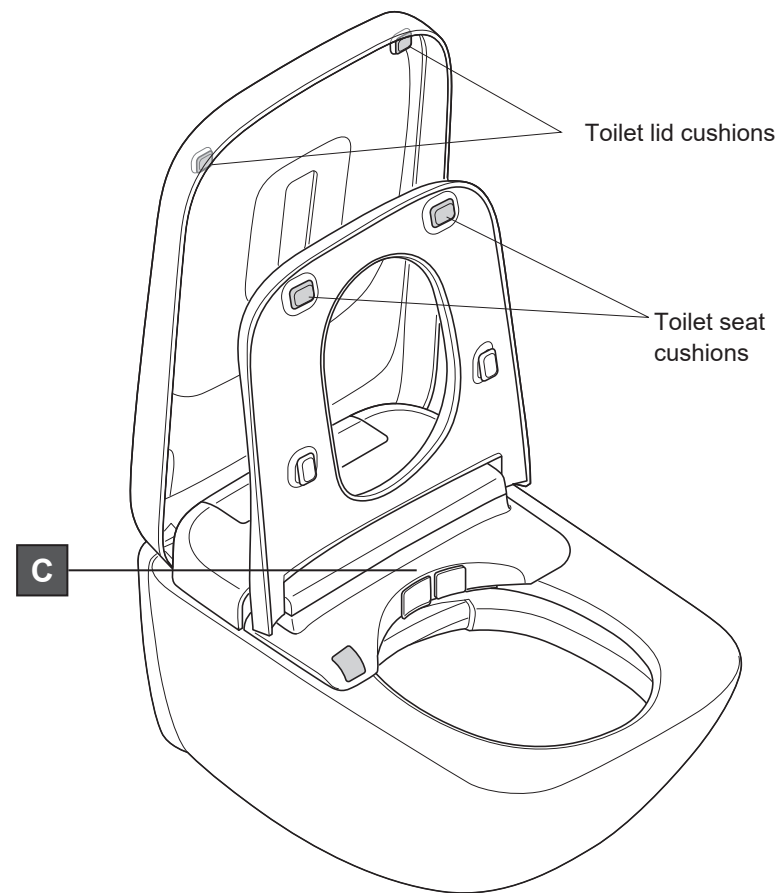
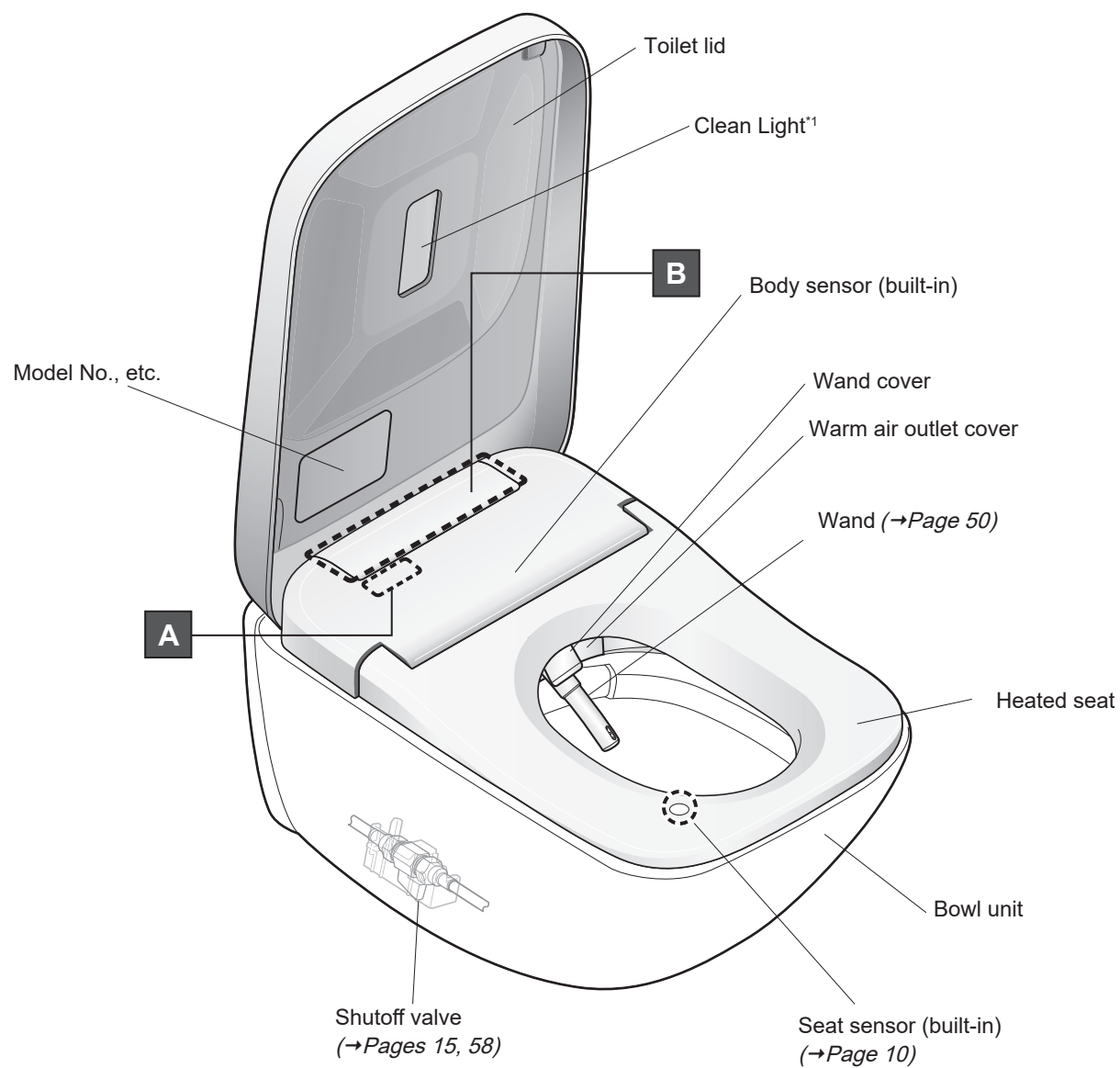

Descriptions in this manual are based on the illustration of SN9548MX.

\*1 For units with the "Clean light function" function only.

# Preparation

## Using the Product for the First Time

### 1. Insert the battery

1.1 Remove the remote control from the hanger.

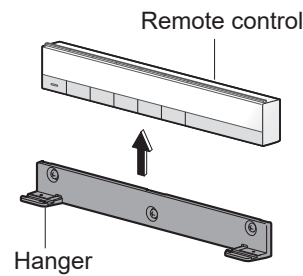

1.2 Open the battery cover and insert two AA batteries. Insert batteries and close the battery cover.

#### Remote control backside

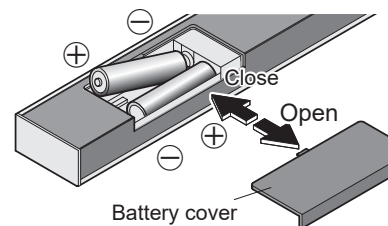

► When batteries are properly inserted, temperature levels appear on the display of the remote control (back side).

#### When the temperature levels are not displayed.

Perform step 3 of "Language Settings".  
(→Page 41)

The display goes out when no button on the remote control is pressed for about 60 seconds or more.

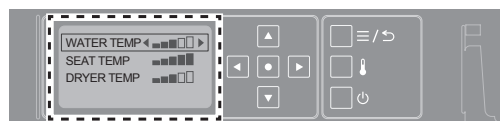

1.3 Mount the remote control in the hanger.

#### About the batteries

Use dry cell, alkaline batteries.

Be sure to follow "Safety Precautions" to prevent the batteries from rupturing or leaking fluid. (→Pages 4, 7)

#### If the remote control is secured to prevent theft

1) Remove the screw from the remote control fixture.  
(2 pieces, left and right)

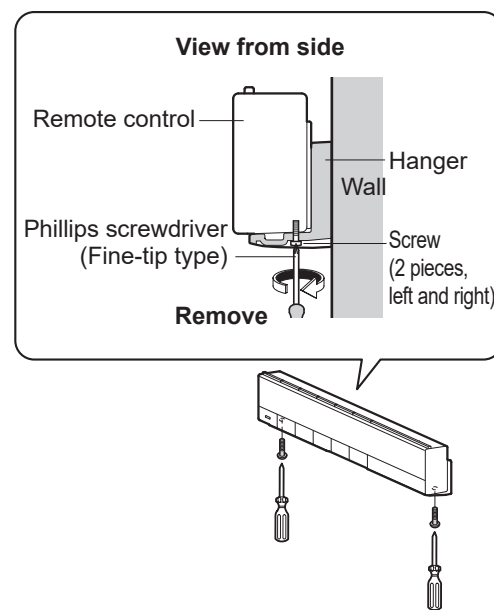

2) Remove the remote control from the hanger.

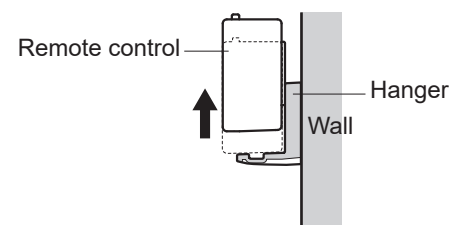

#### To secure the remote control again

Tighten two screws on the left and right to secure it. Overtightening may cause damage to parts such as the hanger.

### 2. Turn on the power

2.1 Switch the breaker on the distribution board to ON.

► The wand extends and then retracts.

2.2 Check the "Power" LED illuminates.

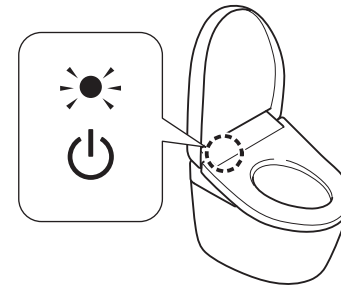

#### If the light is off

1) Remove the cover on the top of the unit, and flip the power switch to "ON".

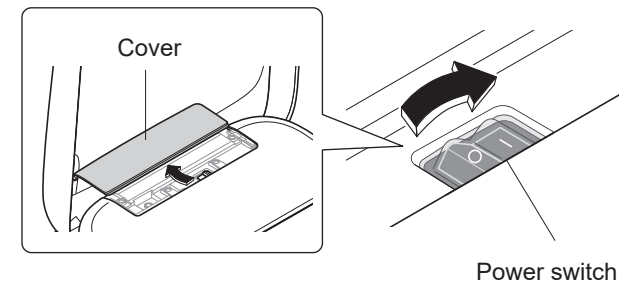

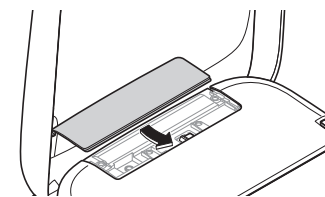

2) Reinstall the cover.



#### If the light is off, but the power switch is "ON"



Switch "Power" to "ON" using the remote control.

#### To operate from the back of remote control

1)    
Press "Power ON/OFF" button about 3 seconds or longer.

#### To operate from the front of remote control

Recommended if the remote control is secured to prevent theft, etc.

1)  and   
Press the "Stop" button and "Water pressure adjustment +" button at the same time for about 10 seconds or longer.

### 3. Open the shutoff valve

3.1 Fully open the shutoff valve.

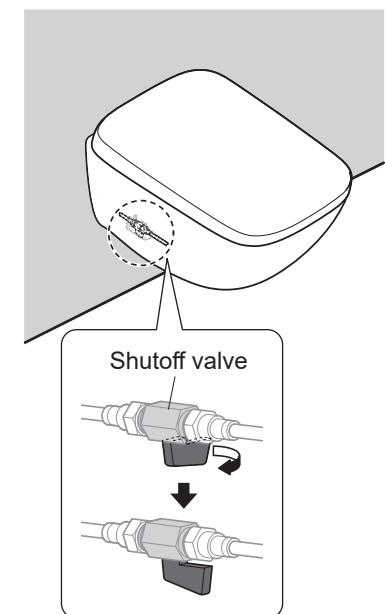



# Preparation

## How to turn off the product

To turn the power "OFF"

- 1) Remove the cover on the top of the unit, and flip the power switch to "OFF".  
▶ The "Power" LED is unilluminated.

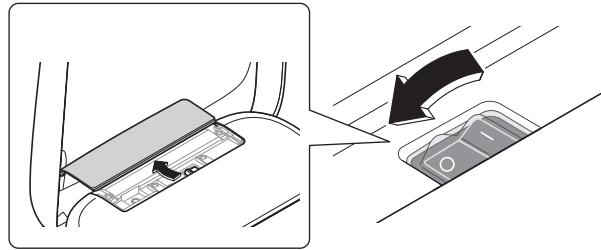

- 2) Reinstall the cover. (→Page 15)

# Basic Operations

## Mechanism of Auto Functions

"EWATER+" is used automatically to clean the wand and bowl unit.

### 1. As you approach

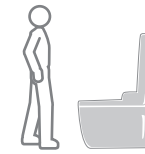

Auto open / close  
Auto bowl CLEAN

#### Auto open / close

The toilet lid opens



When the toilet is used in standing position

Open the toilet seat with the remote control.

#### Auto bowl CLEAN

Pre-mist



The Bowl light lights up

A mist is automatically sprayed inside the bowl unit to make it more difficult for dirt to adhere.

### 2. As you sit\*1



Deodorizer

#### Deodorizer

Starts the deodorizer



Removing odors inside the bowl unit.

**Note:** Deodorizing filter needs regular maintenance. (→Page 51)

### 3. As you stand up\*1



Auto power deodorizer  
Auto flushing  
Auto wand CLEAN

#### Auto power deodorizer

After about 10 seconds

Starts the auto power deodorizer



It stops about 60 seconds after you stand up from the toilet seat

#### Auto flushing

After about 10 seconds

The toilet flushes\*2

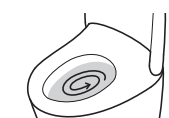

**Note:** The flushing varies depending on how long you sit on the toilet seat.

- Performs a light flush if the time is about 6 to 30 seconds.
- Performs a full flush if the time is about 30 seconds or longer.

\*1 Water comes out from the area around the wand for several seconds while water is warmed up.

\*2 You can change to the setting that closes the toilet lid before flushing the bowl unit. (→Page 32)



# Basic Operations

## Auto wand CLEAN

Only when the washing functions are used

After about 25 seconds

The wand extends to clean with the "EWATER+" that comes out of the base<sup>\*1</sup>

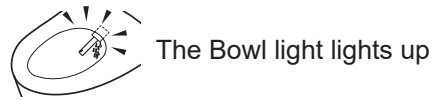

**Note:** "EWATER+" can also be used by pressing the remote control button.  
(→Page 21 "Wand CLEAN")

## 4. As you move away

When you move away



- Auto flushing
- Auto open / close
- Auto bowl CLEAN
- Auto underseat CLEAN
- Clean light function

When the toilet is used in standing position

### Auto flushing

The toilet flushes<sup>\*2</sup>



Performs a light flush.

### Auto open / close

The toilet lid and toilet seat close<sup>\*2</sup>



## Auto bowl CLEAN Auto underseat CLEAN

When you move away

After-mist<sup>\*3</sup>

EWATER+ mist is sprayed on the bowl unit and underneath the front of the toilet seat.<sup>\*4</sup>

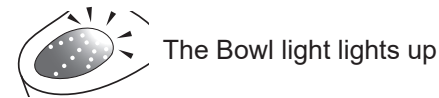

**Note:** "EWATER+" can also be used by pressing the remote control button.  
(→Page 49 "Manual Spray")

## Auto open / close<sup>\*5</sup>

The toilet lid closes<sup>\*2</sup>

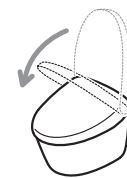

## Clean light function<sup>\*6</sup>

The Clean Light lights up  
(For about 1 hour)

Operation under the default settings is described in "Mechanism of Auto Functions".

These mechanisms be changed.  
(→Pages 26–45 "Changing Settings")

## What is meant by "EWATER+" ?

"EWATER+" helps the self-cleaning wand feature work effectively and by preventing the accumulation of dirt that can cause stains.

- "EWATER+" is generated from chemicals already present in potable water.
- "EWATER+" helps to minimize dirty surfaces, but does not make cleaning unnecessary.
- The effect of rinsing with "EWATER+" can vary depending on the frequency of toilet use and other conditions.

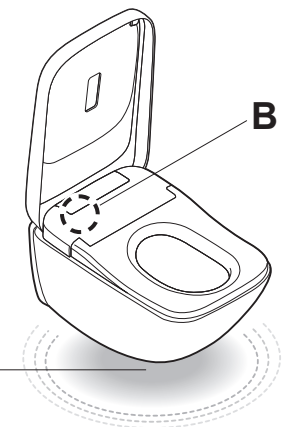

## A Soft light

Lighting up the inside of the bathroom with a soft light.

It lights up as you approach the bowl unit and goes off after you move away from the unit and a certain time has passed.

**Note:** You can turn "Soft light" ON or OFF.  
(→Page 40)

## Night light

You can change "Soft light" and "Bowl light" to "Night mode", a lighting mode suitable for night. (→Page 39)

## B CLEAN indicator

Lights to show that the "Auto bowl CLEAN", "Auto underseat CLEAN", "Deodorizer", "Auto wand CLEAN", and "Manual spray" functions are operating.

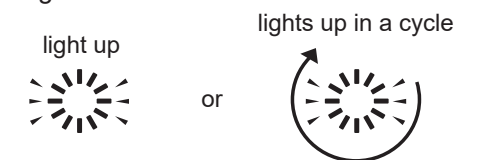

(Lights only when the toilet seat is not in-use)<sup>\*7</sup>

**Note:** You can turn "CLEAN indicator" ON or OFF.  
(→Page 41)

\*1 When the washing functions (Rear washing and Front washing etc.) have not been used in 8 hours, the wand is cleaned automatically. Water comes out from around the wand.

\*2 You can change to the setting that closes the toilet lid before flushing the bowl unit. (→Page 32)

\*3 Mist is sprayed on the bowl unit and underneath the front of the toilet seat that gets dirty easily.

If the toilet lid is closed, it is opened to spray mist.

(If you do not want to open the toilet lid when spraying mist (→Page 62))

\*4 When the washing feature (Rear washing and Front washing etc.) is not used for about 8 hours, mist is sprayed on the bowl unit automatically.

\*5 When you do not sit on the toilet seat, or when you sit on it or stand in front of the bowl unit briefly, it takes about 5 minutes before the lid closes automatically.

\*6 Other than the SN9538M.

\*7 Except "Manual spray"

# Basic Operations

## Using the Remote Control

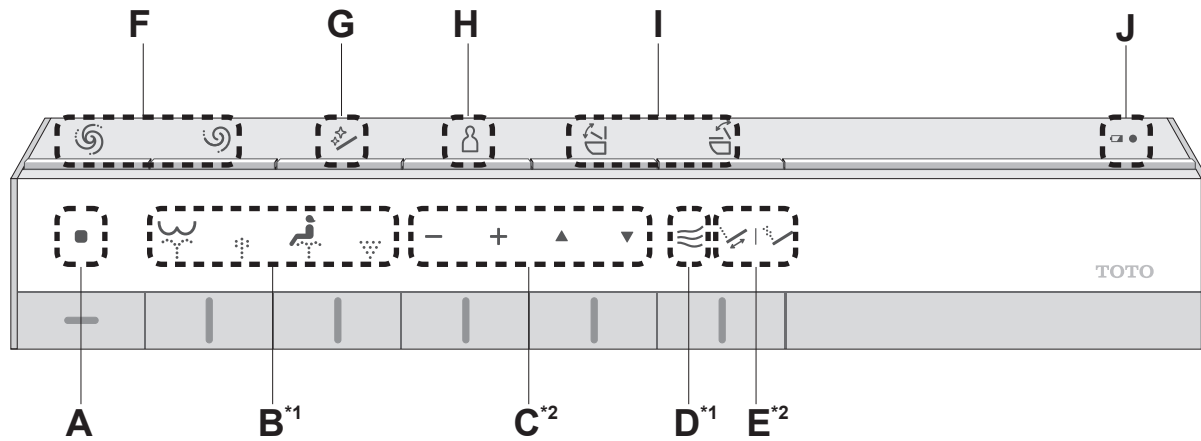

Operate the controls on the remote control; a beep sounds when the top unit receives the signal.

- A** **Stop**  
Stops the B or D operation.
- B** **Rear washing**  
Washes your rear.
- Rear soft washing**  
Washes your rear with soft embracing water flow.
- Front washing**  
Serves as a bidet for ladies.
- Wide front washing**  
Gently washes a wide area.
- C** **Water pressure adjustment**  
You can adjust the water pressure to one of five levels.  
[-] Softer, [+]  
Stronger
- Wand position adjustment**  
You can adjust the washing position to 5 different points between the front and the rear, using the [▲] and [▼] buttons.

- D** **Warm air drying**  
Dries your rear.
  - E** **Oscillating washing**  
The wand moves back and forth to washes your rear thoroughly.
  - Pulsating washing**  
Washes with the water pressure pulsating between soft and strong.
- The washing mode changes each time you press the button.
- 

**Note:** Sitting back on the toilet seat makes it easier to adjust the wand position and to reduce splashing.

Once use of the remote control is finished, the settings will return to the initial setting (3rd position) after a while, not exceeding a maximum of 5 minutes.

If you do not want to return to 3rd position (→Page 42)

**Note:** Sitting back on the toilet seat makes it easier to adjust the wand position and to reduce splashing.

\*1 This cannot be used if the seat sensor is not working. Sit down so that the seat sensor touches your skin directly. (→Page 10)  
\*2 While using B, these buttons and their functions can be operated.

- F** **Full flush<sup>\*3</sup>**  
Performs a full flush.  
Up to 33 ft (10 m) of toilet paper (single)
- Light flush<sup>\*3</sup>**  
Performs a light flush.  
Up to 10 ft (3 m) of toilet paper (single)

- G** **Wand CLEAN**  
Cleans the wand with "EWATER+<sup>\*4</sup>"  
After wand cleaning, water comes out from around the wand.
- Note:** This function will operate automatically after using the washing functions (Rear washing, Front washing, etc.). (→Page 36 "Auto wand CLEAN")  
**Note:** To clean the wand with it extended. (→Page 50 "Wand cleaning")

- H** **Personal setting**  
Up to four people can register their preferred "Water pressure", "Wand position" and "Warm water temperature" settings. (→Page 44)
- To use**
- Press the button and check the beep sound to select the register number.  
REGISTER1: One short beep  
REGISTER2: Two short beeps  
REGISTER3: Three short beeps  
REGISTER4: Four short beeps
  - Press the wash button you want to use ("Rear washing", etc.)

- I** **Opening and closing the toilet lid**  
Opens and closes the toilet lid.
- Opening and closing the toilet seat**  
Opens and closes the toilet seat.

- J** **Low battery warning LED**  
(→Page 53)

### Remote control back side

How to remove the remote control (→Page 14)

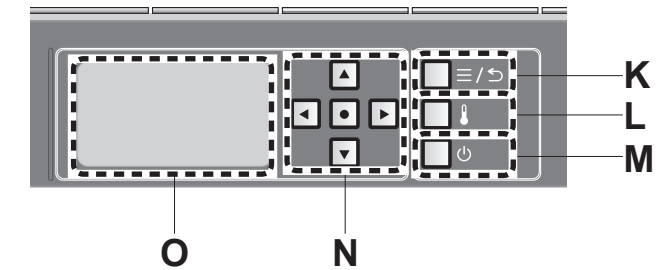

- K** **"Menu, Return" button**  
Adjust settings  
Return to the previous menu

- L** **"Temperature adjustment" button**  
Adjust temperatures  
(→Pages 24, 25)

- M** **"Power ON/OFF" button**  
Pressing it about 3 seconds or longer turns the power on/off.  
▶ If the remote control is secured to prevent theft (→Page 15 Step 2.2.2)

- N** **SELECT keys**  
Select settings.

- Enter button**

- O** **Display screen**

\*3 You can change to the setting that closes the toilet lid before flushing the bowl unit. (→Page 32)

\*4 What is meant by "EWATER+"? (→Page 19)

# Basic Operations

## About the Menu Screen

This section is an overview of the settings that can be configured with the remote control. See the corresponding pages for the detailed descriptions.

### Remote control back side

How to remove the remote control (→Page 14)

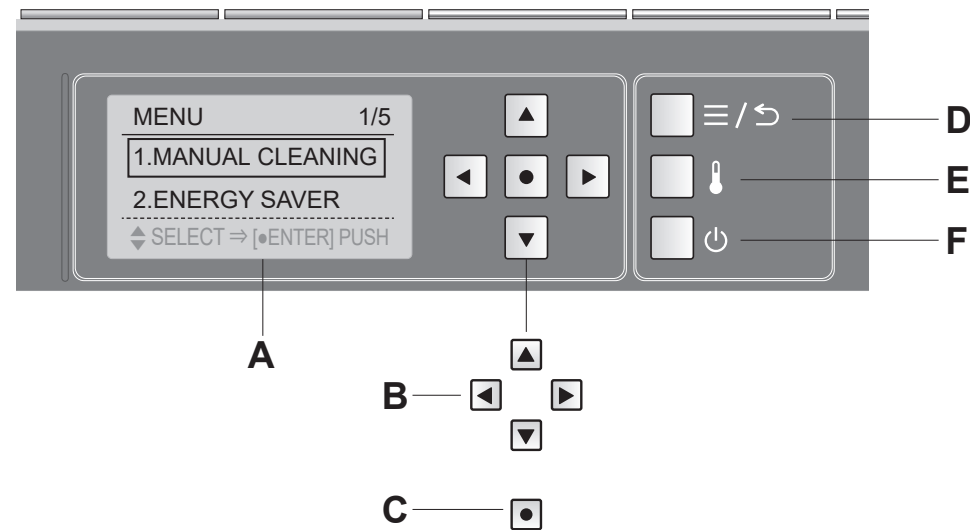

### A Display screen

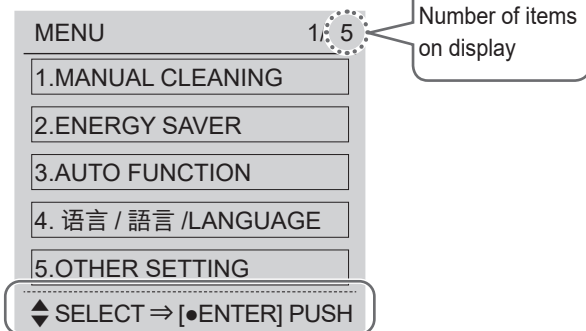

1. Press the "Menu, Return" button.  
▶ The display screen changes.

2. Set the item from the display screen.

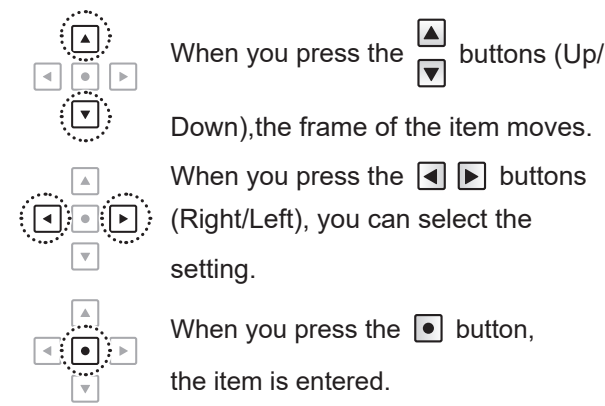

- The next step is shown at the bottom of the display screen.
- B** SELECT keys  
Select a setting
- C** Enter button
- D** "Menu, Return" button
- E** "Temperature adjustment" button  
Adjust temperatures. (→Pages 24, 25)
- F** "Power ON/OFF" button  
Pressing it about 3 seconds or longer turns the power on/off.

## You can set as desired

If you want to return to the previous item, press the "Menu, Return" button.

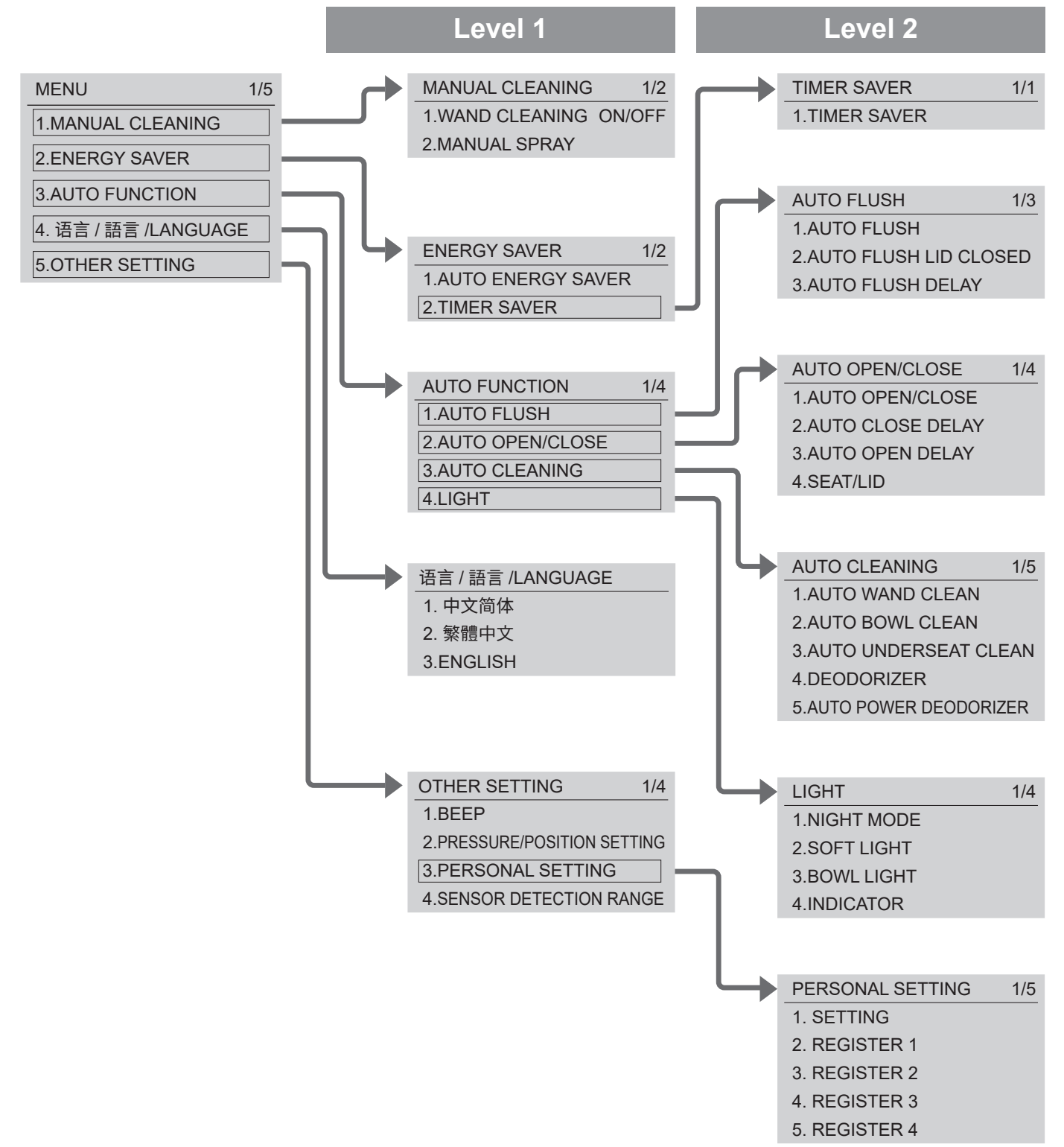

# Temperature Adjustment

## Warm Water, Toilet Seat, Drying

Five different temperature levels from high to low and "OFF" can be set.

### Remote control back side

How to remove the remote control (→Page 14)

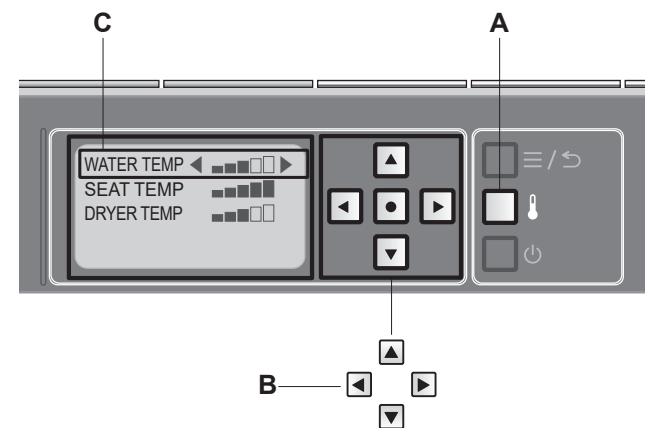

- A "Temperature adjustment" button
- B SELECT keys (Select a setting)
- C Displays the temperature level

**Note:** During setting, the display goes out when no button is pressed within about 60 seconds.

If you fail to complete the setting, redo from the step **1**.

### Warm water temperature

1. Press the "Temperature adjustment" button.

2. Use the "SELECT keys" to select [WATER TEMP].

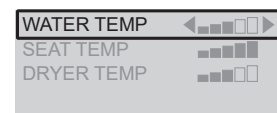

3. Use the "SELECT keys" to select the temperature level.

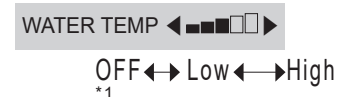

**Note:** If you want to turn it OFF, press the SELECT key until [OFF] appears

### Settings complete

### Toilet seat temperature

1. Press the "Temperature adjustment" button.

2. Use the "SELECT keys" to select [SEAT TEMP].

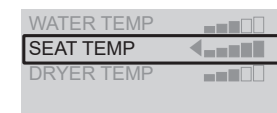

3. Use the "SELECT keys" to select the temperature level.



**Note:** If you want to turn it OFF, press the SELECT key until [OFF] appears.  
 When seat temperature is OFF, the seat LED is unilluminated.

### Settings complete

**If adjusting the temperature does not warm up the toilet seat.**

► Is the energy saver set to "ON"? (→Page 28)

### Drying air temperature

1. Press the "Temperature adjustment" button.

2. Use the "SELECT keys" to select [DRYER TEMP].

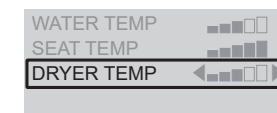

3. Use the "SELECT keys" to select the temperature level.

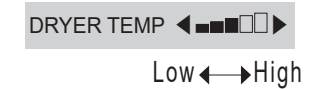

**Note:** The "Drying" cannot be turned "OFF".

### Settings complete

\*1 To prevent condensation, the water temperature does not drop below 68 °F (20 °C) even when set to "OFF".

# Changing Settings

## Setting List

Setting Types	Available Settings Bold: Initial settings
Auto energy saver (→Page 30)	ON/OFF
Auto energy saver+ (→Page 30)	ON/OFF
Timer energy saver (→Page 31)	6H/9H/OFF
Auto flushing (→Page 31)	ON/OFF
Auto flush lid closed (→Page 32)	ON/OFF
Auto flush delay (→Page 32)	SET 1/SET 2/SET 3
Auto open / close (→Page 34)	ON/OFF
Auto close delay (→Page 34)	SET 1/SET 2
Auto open delay (→Page 35)	SET 1/SET 2/SET 3
Seat/lid (→Page 36)	Lid/Seat·Lid
Auto wand CLEAN (→Page 36)	ON/OFF
Auto bowl CLEAN (→Page 37)	ON/OFF
Auto underseat CLEAN (→Page 37)	ON/OFF
Deodorizer (→Page 38)	ON/OFF
Auto power deodorizer (→Page 38)	ON/OFF
Night light (→Page 39)	ON/STANDBY/TIMER
Soft light (→Page 40)	ON/OFF
Bowl light (→Page 40)	ON/OFF
CLEAN indicator (→Page 41)	ON/OFF
Language settings (→Page 41)	Simplified Chinese/Traditional Chinese/English
Beep sound (→Page 42)	ON/OFF*1
Pressure/position setting (→Page 42)	ON/OFF
Personal setting (→Page 43)	ON/OFF
Registering Personal Settings (→Page 44)	Register 1/Register 2/Register 3/Register 4
Sensor detection range (→Page 45)	SET 1/SET 2/SET 3/SET 4/SET 5

\*1 The beep sounds when settings are being changed, even if the beep noise is turned off. (except for "Pressure/position setting" or "Personal setting")

### Setting with buttons on the back of the remote control.

#### Remote control back side

How to remove the remote control (→Page 14)

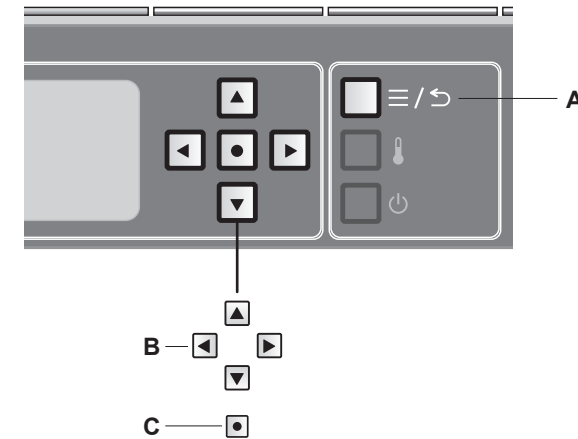

- A "Menu, Return" button
- B SELECT keys
- C Enter button

**Note:** During setting, the display goes out when no button is pressed within about 60 seconds.

If you fail to complete the setting, redo from the step **1**.



# Changing Settings

## The energy saver features

"Auto energy saver", "Auto energy saver+" or "Timer energy saver" can be selected.

To save energy, the temperature of the toilet seat becomes low (or "OFF").

**Note:** Even if the energy saver feature is on (i.e., the toilet seat heater is "OFF"), the seat temporarily becomes warm when approaching the bowl unit or when sitting on the toilet seat.

(It takes about 15 seconds to reach the setting temperature.)

The LED indication on the main display returns to the state for when the energy saver is on.

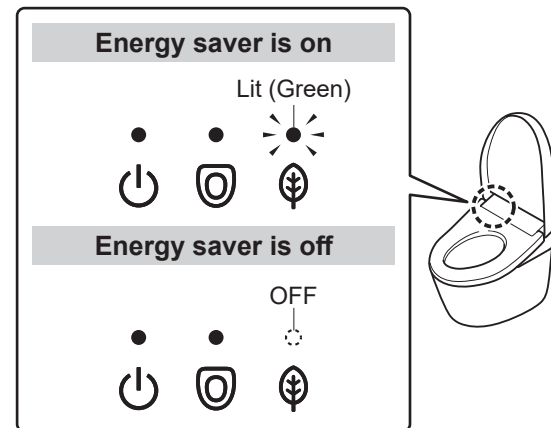

### Auto energy saver

You want the product to save energy automatically

The product detects time periods with infrequent use and lowers the toilet seat temperature automatically.

It takes about 10 days for the product to determine the periods when it is used relatively less frequently.

#### When energy saver is in operation

Main display

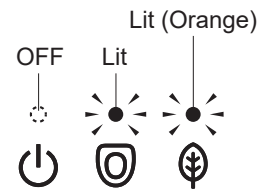

Toilet seat heater



### Auto energy saver+

You want to save more energy

In addition to the "Auto energy saver" feature, it automatically turns off the toilet seat heater during time periods when the toilet is not used.

#### When energy saver is in operation

Main display

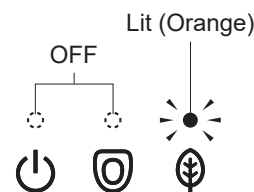

Toilet seat heater

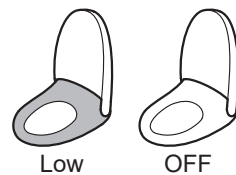

#### Example

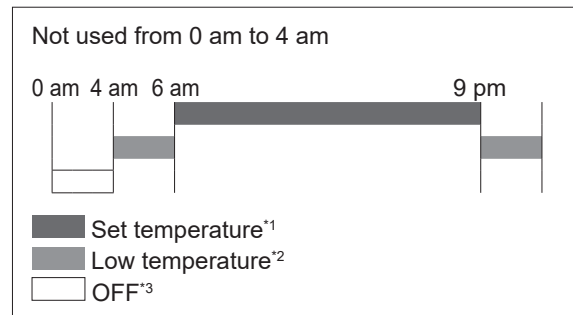

#### Example

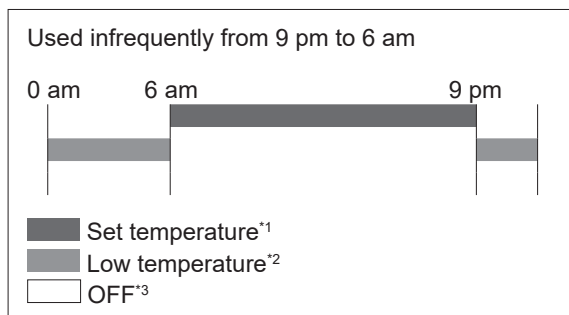

### Timer energy saver

You want to save energy only for a preset duration of time. (6 hours, 9 hours)

Once the time is set, the toilet seat heater turns off automatically during the set time period every day.

#### When energy saver is in operation

Main display

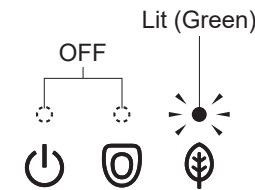

Toilet seat heater



#### Example

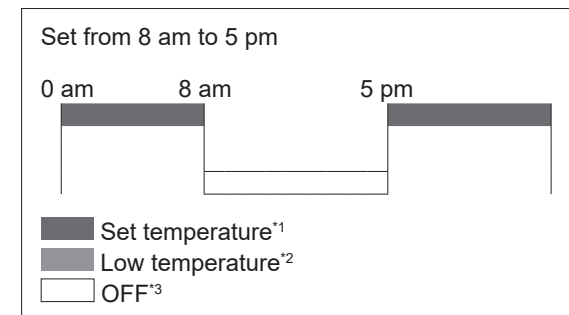

### Timer energy saver and Auto energy saver / Auto energy saver+

You want to save the maximum amount of energy possible?

When both "Timer energy saver" and "Auto energy saver / Auto energy saver+" are set, "Auto energy saver / Auto energy saver+" operates when "Timer energy saver" is not operating.

#### When energy saver is in operation

Main display

During "Auto energy saver / Auto energy saver+":

▶ Same LED indication as "Auto energy saver / Auto energy saver+" (→Page 28)

During "Timer energy saver":

▶ Same LED indication as "Timer energy saver" (→See left)

Toilet seat heater

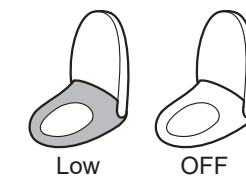

#### Example

When "Timer energy saver" and "Auto energy saver+" are used together

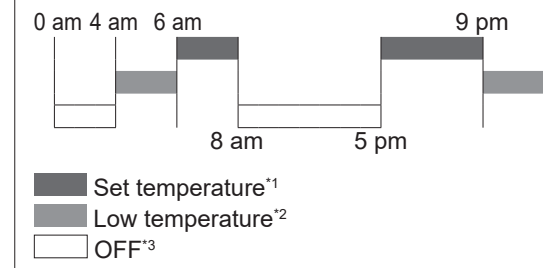

\*1 The toilet seat temperature settings on pages 24, 25.

\*2 The time period when the toilet seat heater is set to a "Low".

\*3 The time period when the toilet seat heater is set to a "OFF".

# Changing Settings

## How to Set

### Auto energy saver

1. Press the "Menu, Return" button.

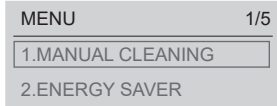

2. Use the "SELECT keys" to select [ENERGY SAVER].

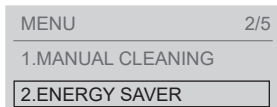

- Press the "Enter" button.

3. Use the "SELECT keys" to select [AUTO ENERGY SAVER].

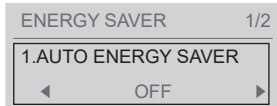

4. Use the "SELECT keys" to select [AUTO ENERGY SAVER].

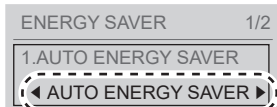

- Press the "Enter" button.

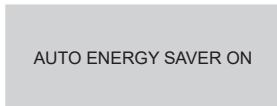

(To return )

### Auto energy saver+

1. Press the "Menu, Return" button.

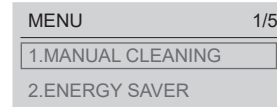

2. Use the "SELECT keys" to select [ENERGY SAVER].

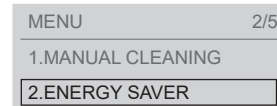

- Press the "Enter" button.

3. Use the "SELECT keys" to select [AUTO ENERGY SAVER].

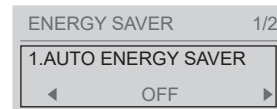

4. Use the "SELECT keys" to select [AUTO ENERGY SAVER+].

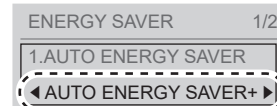

- Press the "Enter" button.

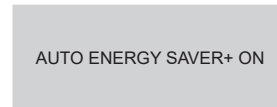

(To return )

### Timer energy saver

Set the "Timer energy saver" at the time you want to start it

1. Press the "Menu, Return" button.

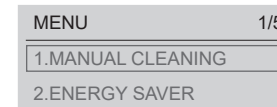

2. Use the "SELECT keys" to select [ENERGY SAVER].

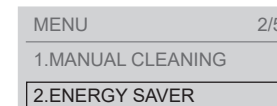

- Press the "Enter" button.

3. Use the "SELECT keys" to select [TIMER SAVER].

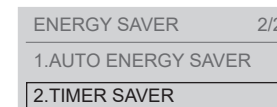

- Press the "Enter" button.

4. Use the "SELECT keys" to select [6H], [9H], or [OFF].

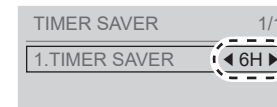

- Press the "Enter" button.

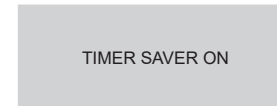

(To return )

To change the timer energy saver time

- ▶ Set the timer energy saver again at the time you want to start it.

### Auto flushing

Set whether or not to clean the bowl unit automatically

1. Press the "Menu, Return" button.

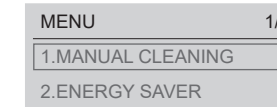

2. Use the "SELECT keys" to select [AUTO FUNCTION].

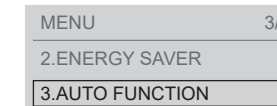

- Press the "Enter" button.

3. Use the "SELECT keys" to select [AUTO FLUSH].

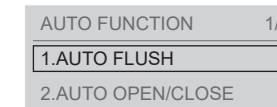

- Press the "Enter" button.

4. Use the "SELECT keys" to select [AUTO FLUSH].



5. Use the "SELECT keys" to select [ON] or [OFF].



- Press the "Enter" button.

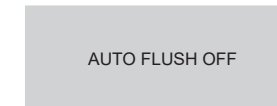

(To return )

# Changing Settings

## Auto flush delay\*1\*2

Change the amount of time before the toilet flushes automatically

1. Press the "Menu, Return" button.

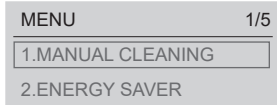

2. Use the "SELECT keys" to select [AUTO FUNCTION].

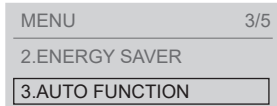

Press the "Enter" button.

3. Use the "SELECT keys" to select [AUTO FLUSH].

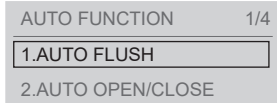

Press the "Enter" button.

4. Use the "SELECT keys" to select [AUTO FLUSH DELAY].

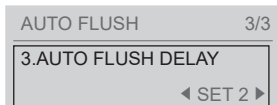

5. Use the SELECT keys to select [SET 1], [SET 2], or [SET 3].



SET 1 (Short) : After about 5 seconds  
SET 2 (Standard): After about 10 seconds  
SET 3 (Long) : After about 15 seconds

If "Auto flush lid closed" is turned ON, the toilet lid closes before flushing the bowl unit as above.

Press the "Enter" button.

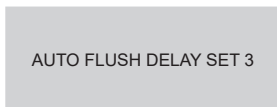

(To return )

## Auto flush lid closed

Set whether or not to close the toilet lid automatically before flushing the bowl unit

1. Press the "Menu, Return" button.

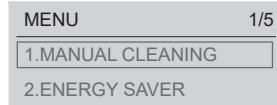

2. Use the "SELECT keys" to select [AUTO FUNCTION].

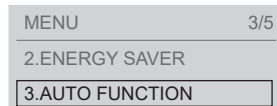

Press the "Enter" button.

3. Use the "SELECT keys" to select [AUTO FLUSH].

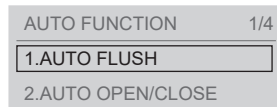

Press the "Enter" button.

4. Use the "SELECT keys" to select [AUTO FLUSH LID CLOSED].

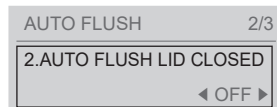

5. Use the "SELECT keys" to select [ON] or [OFF].

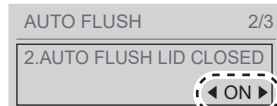

Press the "Enter" button.

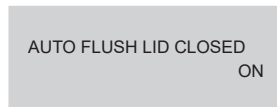

(To return )

## About "Auto flush lid closed"...

About 10 seconds after you stand up or move away if you use the toilet in standing position, the toilet lid closes automatically before flushing the bowl unit.

Also, if you press the Flush buttons ("Full flush" or "Light flush") on the remote control, the toilet lid closes before flushing the bowl unit.

### Using the toilet seat



#### Stand up

The toilet lid closes in about 10 seconds.  
▶ The toilet lid closes before flushing the bowl unit.

### Using the toilet in standing position



#### Move away

The toilet seat and lid close when you move away.  
▶ The toilet seat and lid close before flushing the bowl unit.\*3

### Using the flush buttons on the remote control



#### Press



The toilet lid closes.  
▶ The toilet lid closes before flushing the bowl unit.

"Auto flush lid closed" does not work if "Auto flushing" and "Auto open / close" are set as below: (Except when using the Flush buttons on the remote control)

	Auto flushing	Auto open / close
1)	OFF	ON
2)	ON	OFF
3)	OFF	OFF

- 1) The toilet lid closes automatically but the bowl unit does not flush.
- 2) The bowl unit flushes automatically but the toilet lid does not close.
- 3) The toilet lid does not open / close and the bowl unit does not flush automatically.

Turn both "Auto flushing" and "Auto open / close" ON. (→Pages 31, 34)

Even if "Auto flushing" is turned ON, "Auto flush lid closed" may not work in some cases. For details, refer to "Auto flush lid closed" does not work" in "Troubleshooting". (→Page 63)

**Note:** You can change the length of time before water flushes after closing the toilet lid automatically to [SET 1], [SET 2], or [SET 3]. (→Page 32)

If you get up slightly from the seat or sit leftward on the seat while seated on it, the seat sensor may not detect properly, which results in the toilet lid being closed and bowl unit being flushed. Sit down so that the seat sensor touches your skin directly. (→Page 10)

While using the toilet in standing position, the toilet lid may close and the bowl unit may be flushed. Stand straight in front of the bowl unit.

\*1 This operation cannot be performed if "Auto flushing" is turned OFF.

\*2 The length of time specified for "Auto close delay (Auto flush lid closed)" if "Auto flush lid closed" is turned ON.

\*3 The toilet seat and lid close in about 30 seconds and then the bowl unit flushes.

# Changing Settings

## Auto open / close

Set whether or not to open and close the toilet lid automatically

1. Press the "Menu, Return" button.

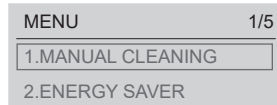

2. Use the "SELECT keys" to select [AUTO FUNCTION].

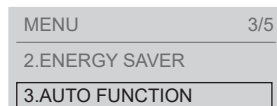

Press the "Enter" button.

3. Use the "SELECT keys" to select [AUTO OPEN / CLOSE].

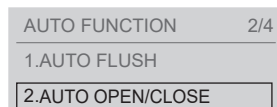

Press the "Enter" button.

4. Use the "SELECT keys" to select [AUTO OPEN / CLOSE].

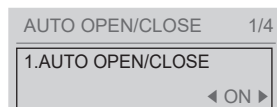

5. Use the "SELECT keys" to select [ON] or [OFF].\*1

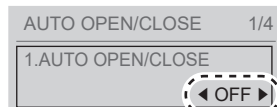

Press the "Enter" button.

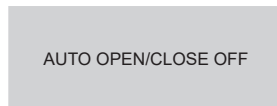

(To return Press the "Menu, Return" button.)

## Auto close delay\*2\*3

Change the amount of time before the lid/seat closes automatically

1. Press the "Menu, Return" button.

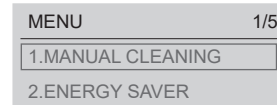

2. Use the "SELECT keys" to select [AUTO FUNCTION].

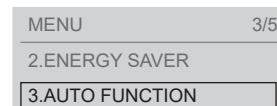

Press the "Enter" button.

3. Use the "SELECT keys" to select [AUTO OPEN / CLOSE].

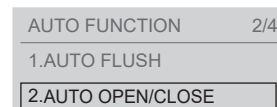

Press the "Enter" button.

4. Use the "SELECT keys" to select [AUTO CLOSE DELAY].

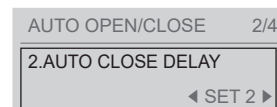

5. Use the "SELECT keys" to select [SET 1] or [SET 2].\*4

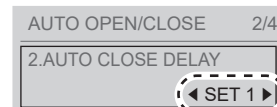

Press the "Enter" button.

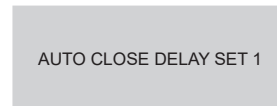

(To return Press the "Menu, Return" button.)

SET 1 (Short) : After about 25 seconds  
SET 2 (Standard) : After about 90 to 120 seconds

## Auto open delay\*2

Change the time period till automatic opening (After closing by hand or remote control.)

1. Press the "Menu, Return" button.

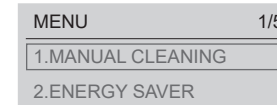

2. Use the "SELECT keys" to select [AUTO FUNCTION].

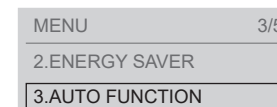

Press the "Enter" button.

3. Use the "SELECT keys" to select [AUTO OPEN / CLOSE].

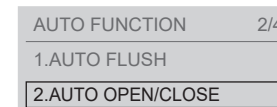

Press the "Enter" button.

4. Use the "SELECT keys" to select [AUTO OPEN DELAY].

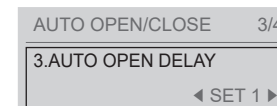

5. Use the "SELECT keys" to select [SET1], [SET2], or [SET3].

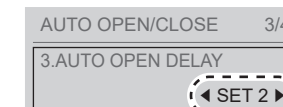

SET 1 (Standard) : After about 15 seconds  
SET 2 (Middle) : After about 30 seconds  
SET 3 (Long) : After about 90 seconds

Press the "Enter" button.

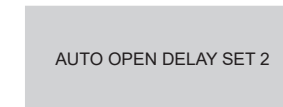

(To return Press the "Menu, Return" button.)

\*1 When the "Auto open / close" is set to "OFF", Clean Light does not work while the lid is open. Please close with your hands or remote control. (Other than the SN9538M)

\*2 This operation cannot be performed if "Auto open / close" is turned OFF.

\*3 If "Auto flush lid closed" is turned ON, you cannot use this setting to change the length of time before closing the toilet lid automatically.

Configure the settings for "Auto flush delay". (→Page 32)

\*4 When set to [SET 1], the lid/seat does not open automatically for about 15 seconds after closing automatically.

# Changing Settings

## Seat/lid\*1

Automatically open and close the toilet lid/  
Automatically open and close the toilet seat and toilet lid

1. Press the "Menu, Return" button.

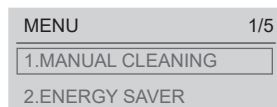

2. Use the "SELECT keys" to select  
 [AUTO FUNCTION].

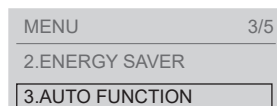

Press the "Enter" button.

3. Use the "SELECT keys" to select  
 [AUTO OPEN / CLOSE].

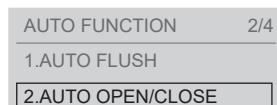

Press the "Enter" button.

4. Use the "SELECT keys" to select  
 [SEAT / LID].



5. Use the "SELECT keys" to select  
[LID] or [SEAT · LID].\*2\*3

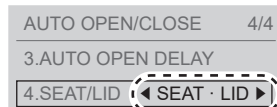

Press the "Enter" button.

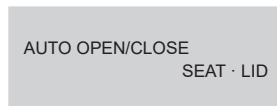

(To return )

## Auto wand CLEAN

Set whether or not to clean the wand automatically

1. Press the "Menu, Return" button.

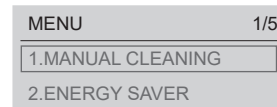

2. Use the "SELECT keys" to select  
 [AUTO FUNCTION].

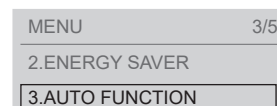

Press the "Enter" button.

3. Use the "SELECT keys" to select  
 [AUTO CLEANING].

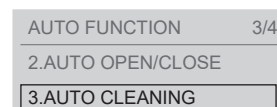

Press the "Enter" button.

4. Use the "SELECT keys" to select  
 [AUTO WAND CLEAN].

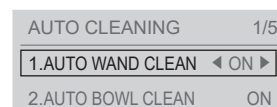

5. Use the "SELECT keys" to select  
[ON] or [OFF].

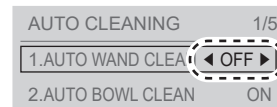

Press the "Enter" button.

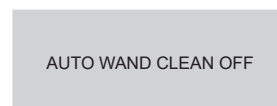

(To return )

## Auto bowl CLEAN\*4

Set whether or not to spray mist in the bowl unit automatically

1. Press the "Menu, Return" button.

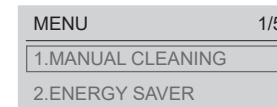

2. Use the "SELECT keys" to select  
 [AUTO FUNCTION].

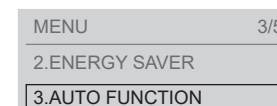

Press the "Enter" button.

3. Use the "SELECT keys" to select  
 [AUTO CLEANING].

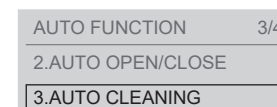

Press the "Enter" button.

4. Use the "SELECT keys" to select  
 [AUTO BOWL CLEAN].

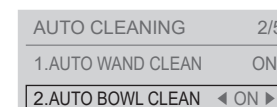

5. Use the "SELECT keys" to select  
[ON] or [OFF].

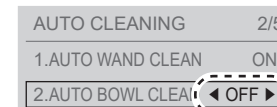

Press the "Enter" button.

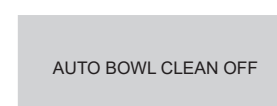

(To return )

## Auto underseat CLEAN\*4

Set whether or not to spray mist to the back of the toilet seat automatically

1. Press the "Menu, Return" button.

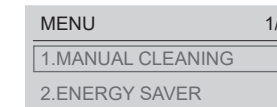

2. Use the "SELECT keys" to select  
 [AUTO FUNCTION].

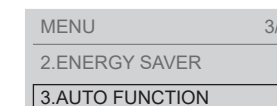

Press the "Enter" button.

3. Use the "SELECT keys" to select  
 [AUTO CLEANING].

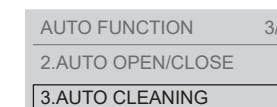

Press the "Enter" button.

4. Use the "SELECT keys" to select  
 [AUTO UNDERSEAT CLEAN].

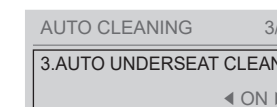

5. Use the "SELECT keys" to select  
[ON] or [OFF].

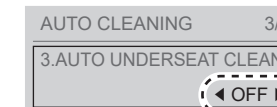

Press the "Enter" button.

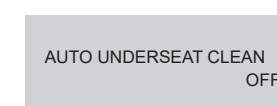

(To return )

\*1 This operation cannot be performed if "Auto open / close" is turned OFF.

\*2 When the [SEAT · LID] are set to open automatically, pre-mist is not sprayed.

\*3 When [SEAT · LID] are set, a light flush may be performed even if you do not stand and use it, depending on the layout of your toilet.

\*4 If "Auto bowl CLEAN" is turned OFF, the mist for "Auto underseat CLEAN" is not sprayed.



# Changing Settings

## Deodorizer

Set whether or not to deodorize automatically after sitting on the toilet seat

1. Press the "Menu, Return" button.

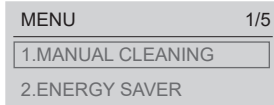

2. Use the "SELECT keys" to select [AUTO FUNCTION].

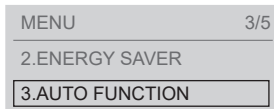

- Press the "Enter" button.

3. Use the "SELECT keys" to select [AUTO CLEANING].

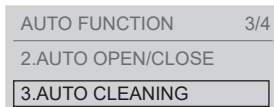

- Press the "Enter" button.

4. Use the "SELECT keys" to select [DEODORIZER].

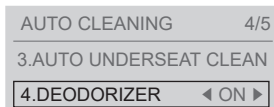

5. Use the "SELECT keys" to select [ON] or [OFF].



- Press the "Enter" button.

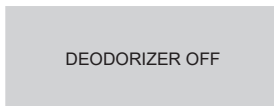

(To return Press the "Menu, Return" button.)

## Auto power deodorizer

Set whether or not to power deodorize automatically after standing up

1. Press the "Menu, Return" button.

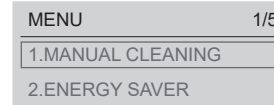

2. Use the "SELECT keys" to select [AUTO FUNCTION].

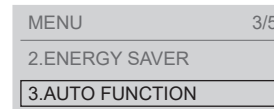

- Press the "Enter" button.

3. Use the "SELECT keys" to select [AUTO CLEANING].

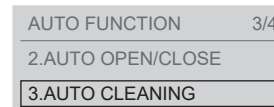

- Press the "Enter" button.

4. Use the "SELECT keys" to select [AUTO POWER DEODORIZER].

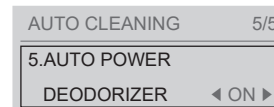

5. Use the "SELECT keys" to select [ON] or [OFF].

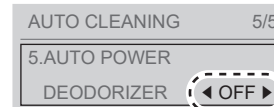

- Press the "Enter" button.

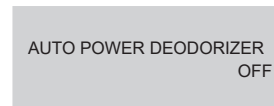

(To return Press the "Menu, Return" button.)

## Night light

Set whether or not to change "Soft light" and "Bowl light" to "Night mode", a lighting mode suitable for night, as well as the time window.

To set the time window (timer), set the desired start time.

1. Press the "Menu, Return" button.

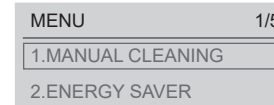

2. Use the "SELECT keys" to select [AUTO FUNCTION].

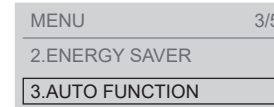

- Press the "Enter" button.

3. Use the "SELECT keys" to select [LIGHT].

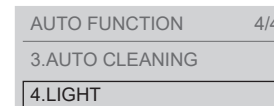

- Press the "Enter" button.

4. Use the "SELECT keys" to select [NIGHT MODE].

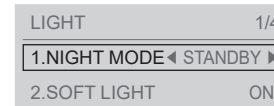

5. Use the "SELECT keys" to select [ON], [STANDBY], or [TIMER].



- Press the "Enter" button.

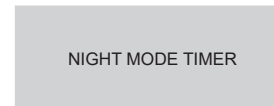

(To return Press the "Menu, Return" button.)

### About "Night light"...

You can change "Soft light" and "Bowl light" to "Night mode", a lighting mode suitable for night.

*Note:* The light does not turn on if "Soft light" and "Bowl light" are turned OFF.

### The "Night light" is turned ON

#### Soft light

Lights permanently

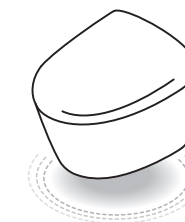

#### Bowl light

Lights up only while someone is detected

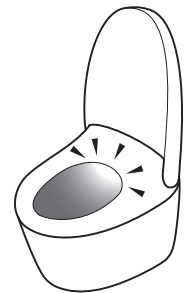

The brightness changes according to human movement.

### The "Night light" is turned OFF [STANDBY]

#### Soft light

Lights up as specified in the settings



#### Bowl light

Lights up as specified in the settings

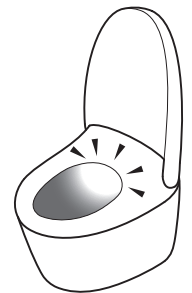

### The "Night light" is configured with the timer



The light turns ON / OFF [STANDBY] every 12 hours starting from the set time.

#### Example

Set from 9 pm to 9 am

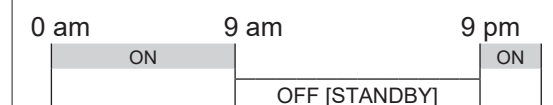

# Changing Settings

## Soft light

Set whether or not to use the soft light

1. Press the "Menu, Return" button.

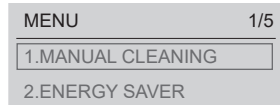

2. Use the "SELECT keys" to select [AUTO FUNCTION].

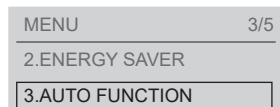

Press the "Enter" button.

3. Use the "SELECT keys" to select [LIGHT].

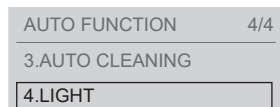

Press the "Enter" button.

4. Use the "SELECT keys" to select [SOFT LIGHT].



5. Use the "SELECT keys" to select [ON] or [OFF].

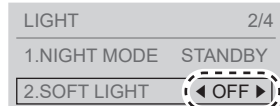

Press the "Enter" button.

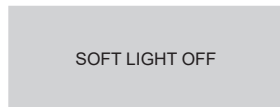

(To return )

## Bowl light

Set whether or not to use the light inside the bowl unit

1. Press the "Menu, Return" button.

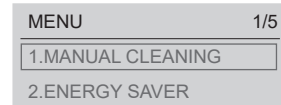

2. Use the "SELECT keys" to select [AUTO FUNCTION].

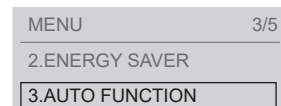

Press the "Enter" button.

3. Use the "SELECT keys" to select [LIGHT].

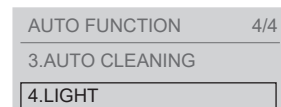

Press the "Enter" button.

4. Use the "SELECT keys" to select [BOWL LIGHT].



5. Use the "SELECT keys" to select [ON] or [OFF].



Press the "Enter" button.

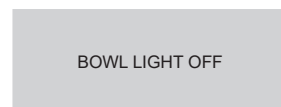

(To return )

## CLEAN indicator

Set whether or not to light up the CLEAN indicator

1. Press the "Menu, Return" button.

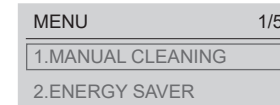

2. Use the "SELECT keys" to select [AUTO FUNCTION].

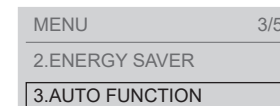

Press the "Enter" button.

3. Use the "SELECT keys" to select [LIGHT].

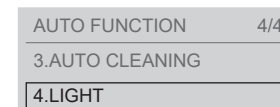

Press the "Enter" button.

4. Use the "SELECT keys" to select [INDICATOR].

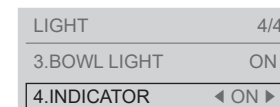

5. Use the "SELECT keys" to select [ON] or [OFF].

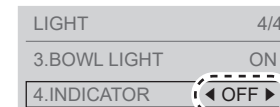

Press the "Enter" button.

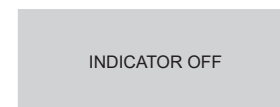

(To return )

## Language settings

Select the language displayed on the back of remote control

1. Press the "Menu, Return" button.

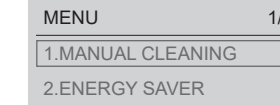

2. Use the "SELECT keys" to select [语言/語言/LANGUAGE].

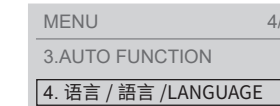

Press the "Enter" button.

3. Use the "SELECT keys" to select [中文简体], [繁體中文] or [ENGLISH].

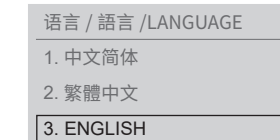

Press the "Enter" button.

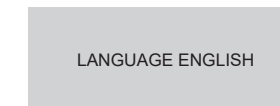

(To return )

# Changing Settings

## Beep sound

Set whether or not to make a beep sound

1. Press the "Menu, Return" button.

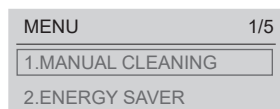

2. Use the "SELECT keys" to select [OTHER SETTING].



- Press the "Enter" button.

3. Use the "SELECT keys" to select [BEEP].

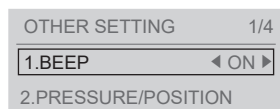

4. Use the "SELECT keys" to select [ON] or [OFF].

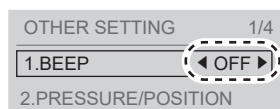

- Press the "Enter" button.

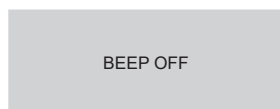

(To return )

## Pressure / position setting

Set whether or not to keep your favorite pressure and position settings

1. Press the "Menu, Return" button.

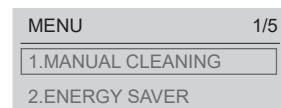

2. Use the "SELECT keys" to select [OTHER SETTING].



- Press the "Enter" button.

3. Use the "SELECT keys" to select [PRESSURE / POSITION SETTING].

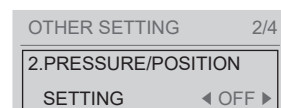

4. Use the "SELECT keys" to select [ON] or [OFF].

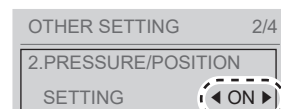

- Press the "Enter" button.

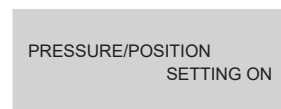

(To return )

## Personal setting

Set whether or not to use the personal setting

1. Press the "Menu, Return" button.

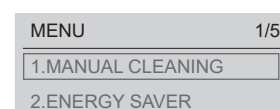

2. Use the "SELECT keys" to select [OTHER SETTING].



- Press the "Enter" button.

3. Use the "SELECT keys" to select [PERSONAL SETTING].

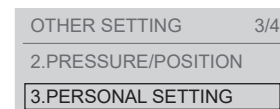

- Press the "Enter" button.

4. Use the "SELECT keys" to select [SETTING].

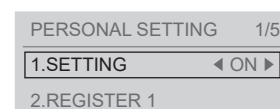

5. Use the "SELECT keys" to select [ON] or [OFF].

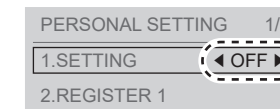

- Press the "Enter" button.

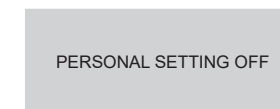

(To return )

# Changing Settings

## Registering Personal Settings

Register your preferred wand position, etc.

1. Press the "Menu, Return" button.

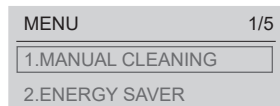

2. Use the "SELECT keys" to select [OTHER SETTING].



Press the "Enter" button.

3. Use the "SELECT keys" to select [PERSONAL SETTING].

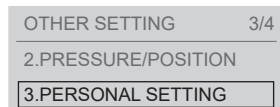

Press the "Enter" button.

4. Use the SELECT keys to select the desired register number from [REGISTER1], [REGISTER2], [REGISTER3] or [REGISTER4].

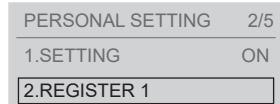

Press the "Enter" button.

5. Use the "SELECT keys" to select [PRESSURE].

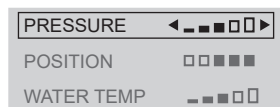

Use the "SELECT keys" to select the "level".

6. Use the "SELECT keys" to select [POSITION].

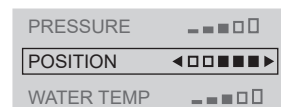

Use the "SELECT keys" to select the "level".

7. Use the "SELECT keys" to select [WATER TEMP].

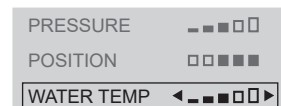

Use the "SELECT keys" to select the "level".

8. Press the "Enter" button.

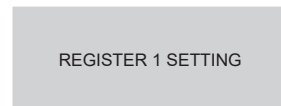

(To return )

## Sensor detection range

You can change when to open the toilet lid upon entering the bathroom

1. Press the "Menu, Return" button.

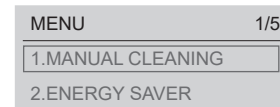

2. Use the "SELECT keys" to select [OTHER SETTING].



Press the "Enter" button.

3. Use the "SELECT keys" to select [SENSOR DETECTION RANGE].

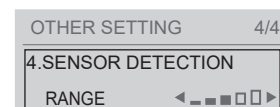

4. Use the "SELECT keys" to select [SET1], [SET2], [SET3], [SET4] or [SET5].

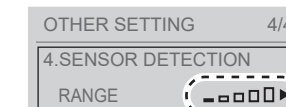

Shortest Longest



(Example) When to open the toilet lid upon entering the bathroom.

Detect nearer

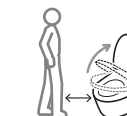

Detect farther

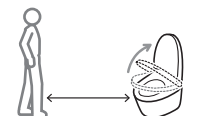

Press the "Enter" button.

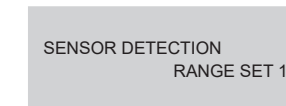

(To return )

# Maintenance

## Before Maintenance

### WARNING

Always turn off the power before maintenance or inspection.

Failure to do so may cause electric shock or malfunction, resulting in a breakdown.

## For safety, turn the power OFF before maintenance.\*1\*2

When the power is turned OFF, the Power LED is unilluminated.

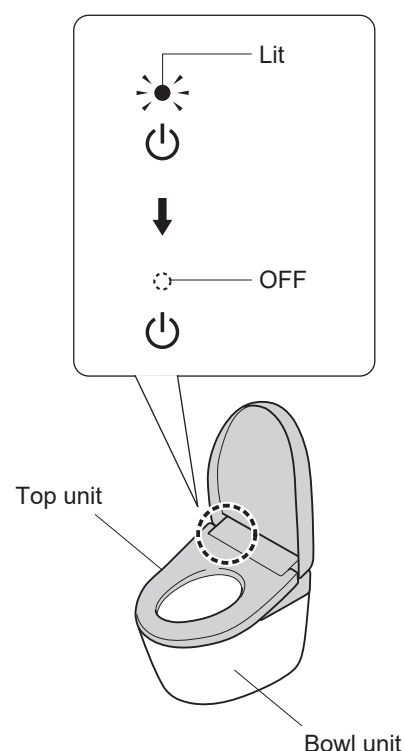

### To turn the power "OFF"

Remove the cover on the top of the unit, and flip the power switch to "OFF".

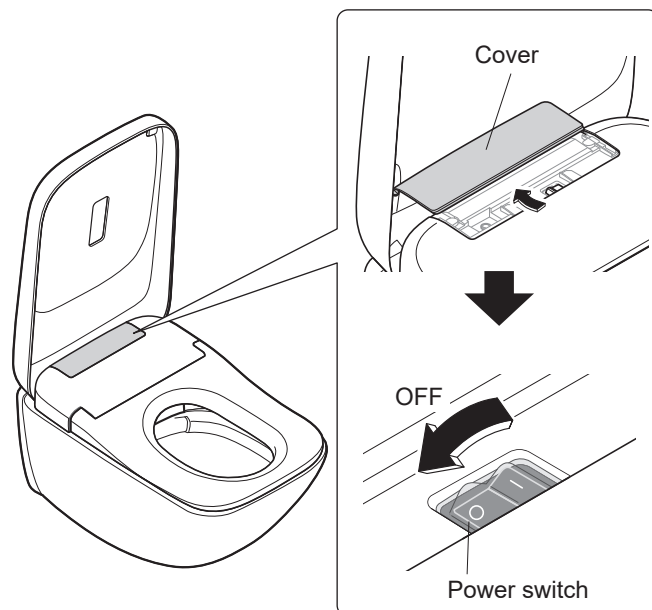



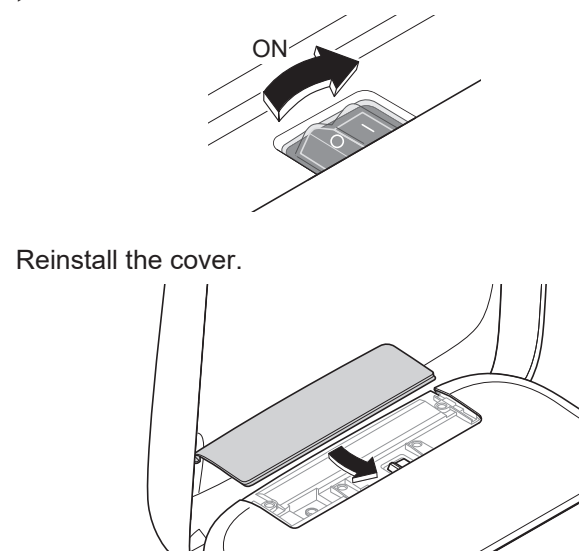

### To turn the power "ON"

Flip the power switch to ON.

▶ The "Power" LED illuminates.



## Top Unit



-  • Soft cloth soaked in water
-  • Toilet paper
-  • Dry cloth
-  • Nylon scrubbing brush
- May cause damage.

### Approximately daily

1. Turn the power "OFF". (→Page 46)
2. Wipe with a soft cloth that has been soaked in water and wrung out thoroughly.

#### For heavy dirt

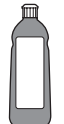
Wipe with a soft cloth soaked in diluted, pH neutral kitchen detergent, and then wipe with a soft cloth soaked in water.

-  • pH neutral kitchen detergent
-  • Paint thinner
- Benzene
- Powdered cleanser

3. Turn the power "ON". (→Page 46)
- ▶ The "Power" LED illuminates.

### Attention

This product is an electric appliance. Be careful not to let water seep inside or leave detergent in the gap between the top unit and bowl unit.

Do not put any cleaning solution directly onto the warm air outlet or cover around the wand, etc. May damage plastic parts or cause a malfunction.

When using a toilet cleaner to clean the toilet, rinse it off within 3 minutes and leave the toilet seat and toilet lid open.

Wipe off any cleaner that remains on the bowl unit. If vapor from a toilet cleaner enters the top unit, it may cause a malfunction.

<If "Auto flush lid closed" (→Pages 32, 33) is turned ON> (→Page 9)

Do not press or pull the warm air outlet or cover around the wand with excessive force.

Doing so may cause damage or failure.

Wipe the back surface of the toilet seat and the toilet seat cushions with a soft cloth tightly wrung out with water.

Otherwise adhesion of dirt may result in discoloration.

Be sure to wipe off any water droplets on the toilet seat.

Otherwise, the seat sensor may malfunction.

\*1 Except when using "Wand cleaning" and "Manual spray"

\*2 The toilet lid does not open automatically for about 20 seconds after the power is turned ON (preparing).

Operate with the remote control.



# Maintenance

## Bowl Unit



- Cleaning sponge
- Brush
- Neutral toilet detergent



- Strongly acidic cleaners or strong alkaline cleaners
- Cleaners containing abrasive compounds
- Fluoride-based detergent (containing hydrogen fluoride or ammonium fluoride)
- Water-repelling cleaner
- Wire brush
- Abrasive nylon scrubbing brush

### Approximately daily

1. Turn the power "OFF". (→Page 46)
2. Clean with a cleaning sponge or brush.
3. Turn the power "ON". (→Page 46)
  - ▶ The "Power" LED illuminates.

### If the bowl unit is clogged

Using plunger or similar, provide 4 in (10 cm) or more clearance between the top of the bowl unit and the water surface. Use commercially available tools that are made for unclogging the bowl unit.

(May cause overflow of dirty water and water damage.)

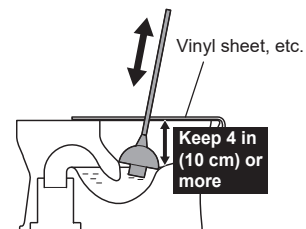

### If the floor is dirty

Clean it with a well wrung cloth.

(Otherwise, stains or corrosion may occur on the floor.)

**Note:** *Sitting is recommended to reduce splashing caused by standing and urinating.*

### Attention

**Be careful not to expose the top unit or the gap between it and the bowl unit to water.**

(Otherwise, water may overflow into the room.)

**Do not use any water repellent, stain-proofing cleaner or surface coating agent.**

These products would not damage the porcelain surface, but they may cover the porcelain surface and reduce the effect of the built-in stain prevention technology.

## SN9548MX

### Approximately once a month

To preserve the performance of the clean light function, clean the toilet bowl surface with a toilet brush, etc. using commercially available hydrochloric acid-based or inorganic acid-based detergent.

## Manual Spray

EWATER+ mist can be sprayed to separate dirt from the surface for maintenance.

### Approximately daily

#### Remote control back side

How to remove the remote control (→Page 14)

- 1) Press the "Menu, Return" button.
- 2) Use the "SELECT keys" to select [MANUAL CLEANING].  
 Press the "Enter" button.
- 3) Use the "SELECT keys" to select [MANUAL SPRAY].  
 Press the "Enter" button.

- ▶ EWATER+ mist is sprayed on the bowl unit and underneath the front of the toilet seat. Wipe off the back of the toilet seat with a soft cloth every time mist is sprayed. Then, perform maintenance on the bowl unit. (→Page 48)

**Note:** *It cannot be used when the wand is out or when you are sitting on the toilet seat.*

# Maintenance

## Wand

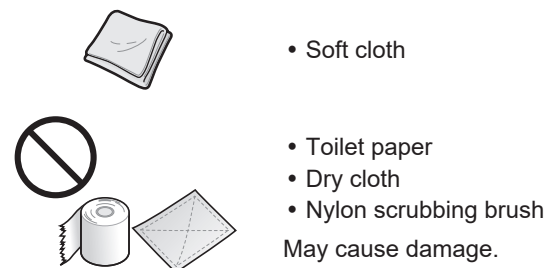

### Approximately once a month If you notice dirt (Wand cleaning)

#### 1. Extend the wand.

##### To operate from the back of remote control

###### Remote control back side

How to remove the remote control (→Page 14)

- 1) Press the "Menu, Return" button.
- 2) Use the "SELECT keys" to select [MANUAL CLEANING].  
 Press the "Enter" button.
- 3) Use the "SELECT keys" to select [WAND CLEANING ON/OFF].  
 Press the "Enter" button.

- ▶ The wand extends and water sprays out for cleaning.
- ▶ The wand automatically retracts after about 5 minutes.

##### To operate from the front of remote control

Recommended if the remote control is secured to prevent theft, etc.

- 1) Press "Stop" button for about 10 seconds or longer.
- 2) Press "Front washing" button for about 3 seconds or longer.

- ▶ The wand extends and water sprays out for cleaning.
- ▶ The wand automatically retracts after about 5 minutes.

#### 2. Wipe with a soft, wet cloth.

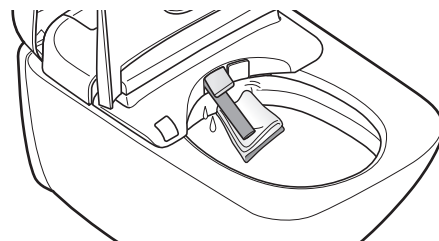

#### Attention

**Do not pull, push or press the wand with excessive force.**  
May cause damage or malfunction.

#### 3. ■

Press "Stop" button on the front side of the remote control.

- ▶ The wand retracts.

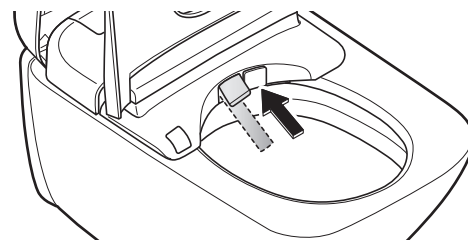

## Deodorizing Filter

### Approximately once a month

#### 1. Turn the power "OFF". (→Page 46)

#### 2. Hold the tab of the deodorizing filter and pull it out toward you.

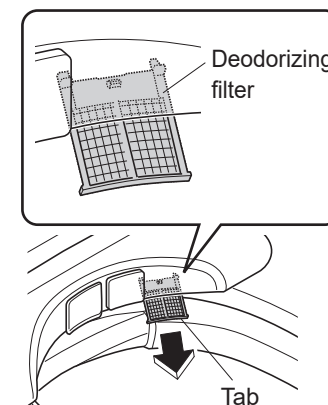

#### Attention

**The deodorizing filter cannot be removed completely.**  
**Do not pull the unit with undue force.**  
Doing so may cause damage or malfunction.

#### 3. Clean with a tool such as a toothbrush.

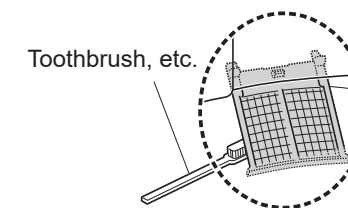

#### 4. Push in the deodorizing filter.

- 1) Push firmly until it is in the original position.

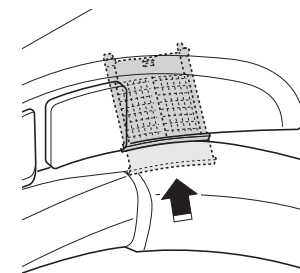

#### 5. Turn the power "ON". (→Page 46)

- ▶ The "Power" LED illuminates.

# Maintenance

## Drain Plug With Water Supply Filter

Approximately once every 6 months  
If you think the water pressure has weakened

1. Close the shutoff valve. (→Page 58)  
▶ The water supply stops.

### CAUTION

Do not remove the drain plug with water supply filter while the shutoff valve is open. Otherwise, water may leak out.

2.  Press "Wand CLEAN" button.  
(Release the pressure from the water supply pipe.)

3. Turn the power "OFF". (→Page 46)

4. Open the toilet seat and lid.

5. Open the cover and remove the drain plug with water supply filter.

- 1) Insert a flat-head screwdriver in the hook of the cover to open it.

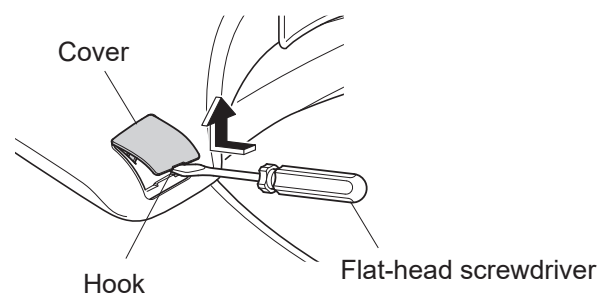

- 2) Loosen the drain plug with water supply filter with a flat-head screwdriver and then pull it.

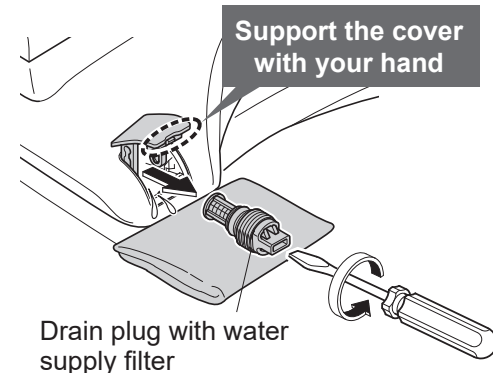

6. Clean the filter with a tool such as a toothbrush.  
▶ Also, remove any dust from inside the hole of the drain plug with water supply filter.

7. Reinstall the drain plug with water supply filter and close the cover.

- 1) Insert the drain plug with water supply filter and use a flat-head screwdriver to tighten it securely.

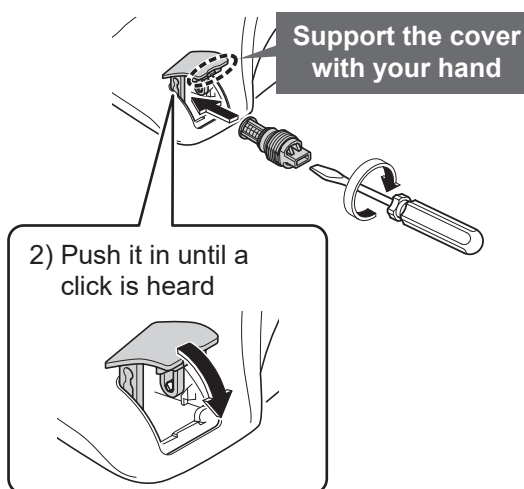

8. Turn the power "ON". (→Page 46)  
▶ The "Power" LED illuminates.

9. Open the shutoff valve. (→Page 15)

# What to Do?

## If there is no water due to a power outage or water failure

### If a power outage occurs

1. Press the button on the flush panel to flush.

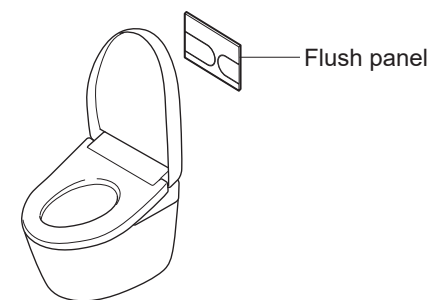

### If a water outage occurs

1. Use a bucket to flush the bowl unit.  
(About 6–8 L)

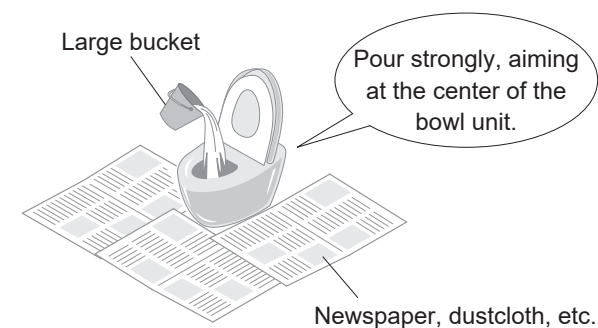

2. If the water level is low after flushing, add more water.  
(Until the water level does not rise further.)  
▶ Prevents odors.

### Attention

If there is a water supply failure, set the auto bowl unit cleaning to "OFF". (→Page 31)

When the water supply is restored, make sure to first use water in the bath or kitchen (not with this product) to remove air from the water supply pipes.

Otherwise, air or foreign objects may enter this product, causing failure.

When the water supply is restored, be sure to perform a flush.

To prevent waste from remaining in the drain pipe.

## If you cannot operate with the remote control

If the low battery warning LED is flashing, replace the batteries.

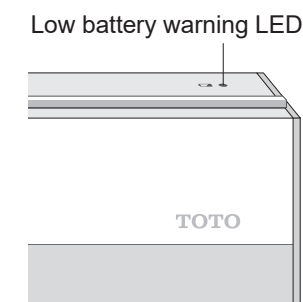

## Replacing the batteries

1. Turn the power "OFF". (→Page 16)
2. Remove the remote control from the hanger. (→Page 14)
3. Open the battery cover and replace two AA batteries. (→Page 14)  
▶ The low battery warning LED goes off.
4. Mount the remote control in the hanger. (→Page 14)
5. Turn the power "ON". (→Page 15)  
▶ The "Power" LED illuminates.

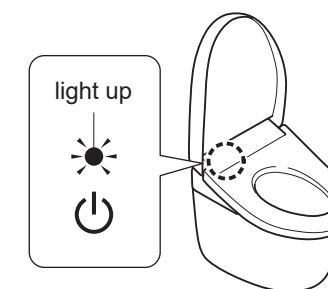

### Attention

"ON" and "OFF" settings of the functions such as the energy saver function may be canceled when the batteries are replaced. Set them again.

# What to Do?

## Freeze Damage Prevention

When the ambient temperature is likely to drop to 32 °F (0 °C) or lower, take measures to prevent freezing.

### Attention

When the ambient temperature is likely to drop to 32°F (0 °C) or lower, do not use the energy saver feature. Otherwise, the product may break down.

Warm the bathroom or take measures against freezing so that the ambient temperature does not drop below 32 °F (0° C).

Before starting to work, set "Auto flushing" (→Page 31) and "Auto open / close" (→Page 34) to "OFF".

1. Close the shutoff valve. (→Page 58)
  - ▶ The water supply stops.

### CAUTION

Do not remove the drain plug with water supply filter while the shutoff valve is open. Otherwise, water may leak out.

2.  Press "Wand CLEAN" button. (Release the pressure from the water supply pipe.)

3. Turn the power "OFF". (→Page 16)

4. Open the toilet seat and lid.

5. Open the cover and remove the drain plug with water supply filter.

- 1) Insert a flat-head screwdriver in the hook of the cover to open it.

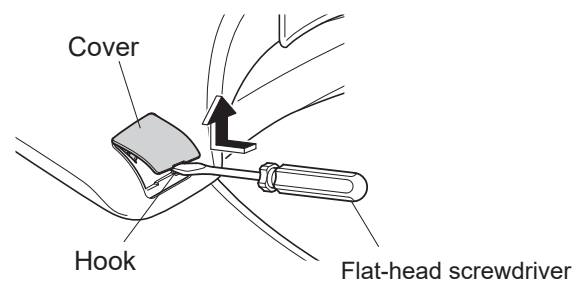

- 2) Loosen the drain plug with water supply filter with a flat-head screwdriver and then pull it.

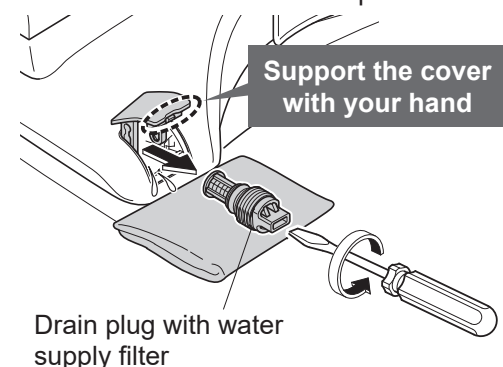

6. When water draining is completed, reinstall the drain plug with water supply filter and cover.

- 1) Insert the drain plug with water supply filter and use a flat-head screwdriver to tighten it securely.

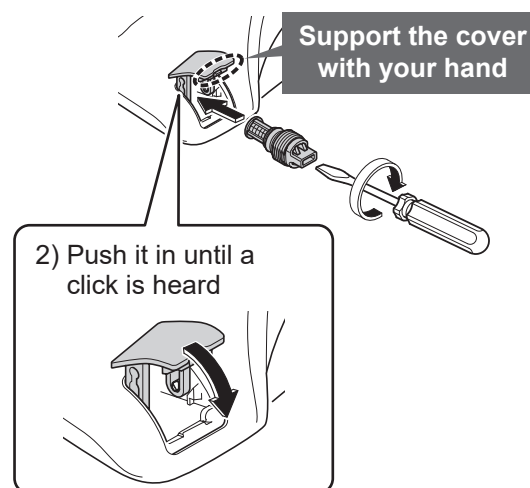

7. Turn the power "ON". (→Page 15)

- ▶ The "Power" LED illuminates.

8. Set the toilet seat temperature to "High". (→Page 25)

- ▶ To maintain the temperature, close the toilet seat and toilet lid after finishing work.

### To use the product again

- ▶ The water needs to be resupplied. (→Page 56)

## Long Periods of Disuse

If the toilet is in a location you will not visit for a long time, drain the water.

The water in the tank may cause malfunctions or become contaminated and cause skin irritation or other problems.

The water may freeze, causing damage to the product.

### Attention

When there is a risk of freezing, take measures to prevent freezing. (→Page 54) Otherwise, the product may break down.

## How to drain the water

1. Close the shutoff valve. (→Page 58)
  - ▶ The water supply stops.

### CAUTION

Do not remove the drain plug with water supply filter while the shutoff valve is open. Otherwise, water may leak out.

2.  Press "Wand CLEAN" button. (Release the pressure from the water supply pipe.)

3. Turn the power "OFF". (→Page 16)

4. Open the toilet seat and lid.

5. Open the cover and remove the drain plug with water supply filter.

- 1) Insert a flat-head screwdriver in the hook of the cover to open it.

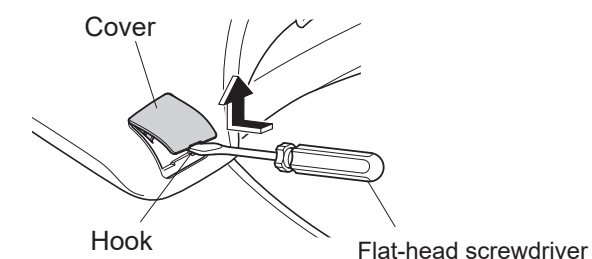

# What to Do?

## Long Periods of Disuse (Continued)

- 2) Loosen the drain plug with water supply filter with a flat-head screwdriver and then pull it.

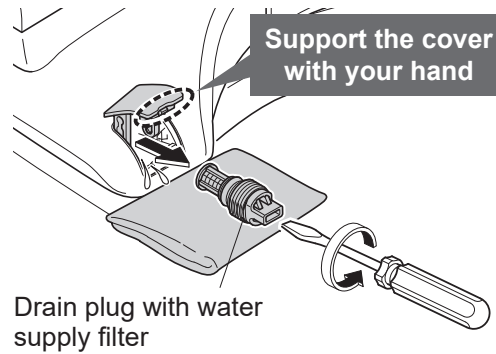

6. When water draining is completed, reinstall the drain plug with water supply filter and cover.

- 1) Insert the drain plug with water supply filter and use a flat-head screwdriver to tighten it securely.

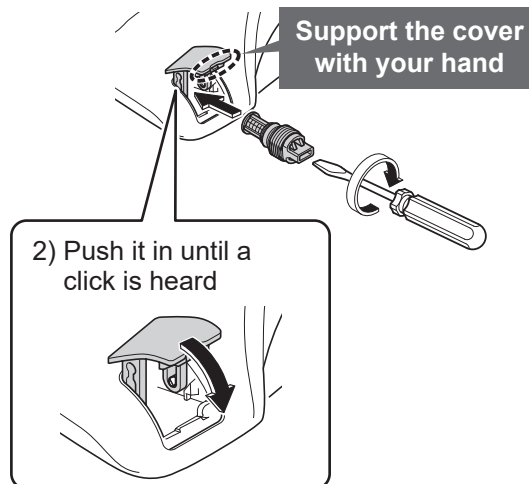

### If water may get frozen

- Add antifreeze solution to the water in the bowl to prevent freezing.  
The antifreeze solution should not be flushed out. Collect it before using the toilet and dispose of it.

### To use the product again

- The water needs to be resupplied. (→ See right)

## Resupplying the Water

1. Open the shutoff valve. (→Page 15)
  - Check that water is not leaking from a pipe or the top unit.
2. If the power is not on, turn the power ON. (→Page 15)
  - The "Power" LED illuminates.
3. Discharge water from the wand.
  - 1) Keep your hand or arm in contact with the seat sensor (for details, →refer to Page 10)
  - 2)  Press "Rear washing" button to discharge water from the wand.
    - Catch the water in a paper cup or other receptacle.
  - 3) Move your hand or arm from the seat sensor

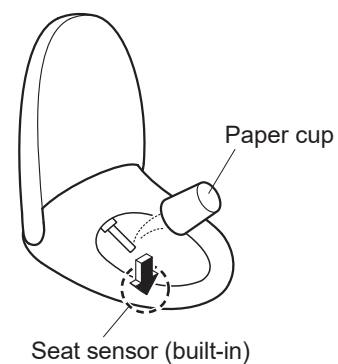

### If the remaining water has frozen and no water comes out

- Heat the inside of the bathroom, and warm the water supply hose and shutoff valve using a cloth soaked in warm water.

## How to remove the operation guide

To remove, follow the procedure below.

1. Turn the power "OFF". (→Page 16)
2. Remove the remote control from the hanger. (→Page 14)
3. Remove the hanger and operation guide.

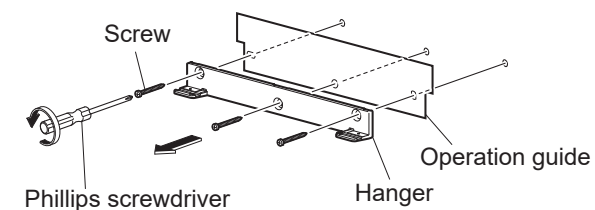

4. Screw the hanger on the wall.

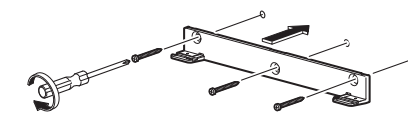

5. Mount the remote control in the hanger.

6. Turn the power "ON". (→Page 15)
  - The "Power" LED illuminates.

To install back the operation guide, follow the procedure above.

- Install the operation guide at step 4.



# Troubleshooting

First, try the actions described on pages 59–67. If the problem persists, consult the installer, seller, or TOTO Service (→see contact information on the back cover).

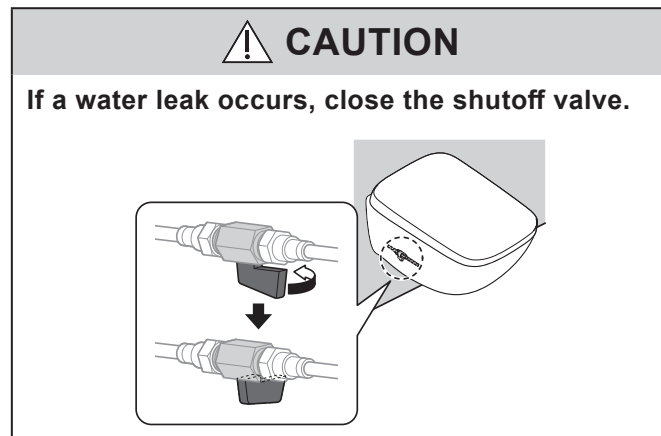

In the following cases, cut off the power by flipping the power switch to OFF or switching the breaker on the distribution board to OFF, etc., and consult with TOTO customer service. (→see contact information on the back cover).

"Power" LED, "Seat" LED, and "Energy saver" LED are flickering

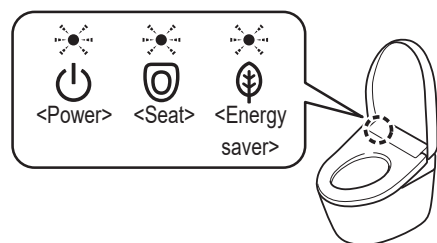

## Please check first (A–C)

**A:** Is the Power LED illuminated?  
Is the top unit working?

**Is the breaker on the distribution board turned on?**

- ▶ Check whether there is a power outage or the breaker has turned "OFF".

**Is the power switch flipped to "OFF"?**

- ▶ Flip it to "ON". (→Page 15 step 2-2.2)

**Is the "Power ON/OFF" setting "OFF"?**

- ▶ Switch it to "ON" with the remote control. (→Page 15 step 2-2.2)

**B:** Is the Energy saver LED lit?

- ▶ While the LED is lit, energy saver (→Page 28) is in operation, so the toilet seat temperature may be reduced or the heater may be turned off.

**C:** Is the remote control working?

**Is the low battery warning LED on the top surface of the remote control flashing?**

- ▶ Replace the batteries (→Pages 14, 53)

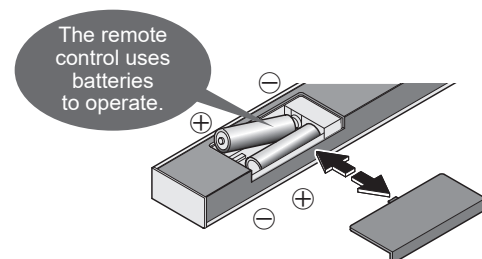

**Is there a metal object placed near the top unit or remote control?**

- ▶ Move the metal object.

## Rear Washing, Front Washing and Wand

Trouble	Please check
<b>The wand (or washing water) does not come out</b>	<p>When the temperature is low, it takes time for the wand to come out after the remote control button is pressed because the water must be warmed up first.</p> <p>Has the toilet been sat "ON" and used continuously for 2 hours or longer? (If so, operation is stopped for safety purposes.)</p> <ul style="list-style-type: none"> <li>▶ Stand up from the seat and then use again.</li> </ul> <p>If the water supply pressure drops significantly, for example if water is used elsewhere or if there is a water failure, the function may stop for safety.</p> <ul style="list-style-type: none"> <li>▶ Turn the power OFF and wait about 10 seconds before turning the power ON again. (→Pages 15, 16)</li> </ul> <p><b>If the above symptom reappears</b> There may be a malfunction.</p> <ul style="list-style-type: none"> <li>▶ Consult with TOTO customer service (→see contact information on the back cover)</li> </ul> <p>When sitting on the toilet seat, is there a toilet seat cover or clothing on the seat sensor? Or are you sitting without touching the seat sensor?</p> <ul style="list-style-type: none"> <li>▶ Check the location of the seat sensor and sit down so that it touches your skin directly. (→Page 10)</li> </ul> <p>Are you using a toilet seat cover, a toilet lid cover or a seat for infants? ▶ Remove any covers. When using a seat for infants or a soft highchair, remove after each use. (→Page 9)</p> <p>Are you pressing "Wand CLEAN" button? When you press "Wand CLEAN" button, "EWATER+" comes out from the vicinity of the wand to clean the wand.</p> <ul style="list-style-type: none"> <li>▶ To clean the wand with it extended, perform "Wand cleaning". (→Page 50)</li> </ul>
<b>The wand extends but the washing water does not come out / The washing water pressure is weak</b>	<p>Has a water failure occurred?</p> <ul style="list-style-type: none"> <li>▶ Press "Stop" button on the remote control and wait until water service is restored.</li> </ul> <p>Is the shutoff valve closed?</p> <ul style="list-style-type: none"> <li>▶ Fully open the shutoff valve. (→Page 15)</li> </ul> <p>Is the drain plug with water supply filter clogged with foreign matter?</p> <ul style="list-style-type: none"> <li>▶ Clean the filter. (→Page 52)</li> </ul> <p>Is the water pressure set to a low level? (→Page 20)</p>
<b>The washing water is cold</b>	<p>Is the warm water temperature set to "OFF" or a low level? (→Page 24)</p> <p>When the temperature of the water supply or the bathroom is low, the water temperature may be low when first sprayed.</p>
<b>Stops in the middle of use</b>	<p>"Rear washing", "Rear soft washing", "Front washing", and "Wide front washing" stop automatically after about 5 minutes of continuous use.</p> <p>Does the seat sensor have difficulty detecting?</p> <ul style="list-style-type: none"> <li>▶ If you get up slightly from the seat or sit leftward on the seat, the seat sensor may temporarily stop detecting your presence, causing washing to stop prematurely. (→Page 10)</li> </ul>

# Troubleshooting

## Rear Washing, Front Washing and Wand (continue)

Trouble	Please check
<b>Water comes out unexpectedly from the wand</b>	When you sit on the toilet seat, water comes out for several seconds while water is warmed up. Has the CLEAN indicator lit up in a cycle? ▶ "Auto wand CLEAN" starts and the wand is cleaned. (→Page 19)

## Warm air drying

Trouble	Please check
<b>The dryer temperature is low</b>	Is the dryer temperature set to low level? (→Page 25)
<b>Stops in the middle of use</b>	The feature stops automatically after about 10 minutes of continuous use. Does the seat sensor have difficulty detecting? ▶ If you get up slightly from the seat or sit leftward on the seat, the seat sensor may temporarily stop detecting your presence, causing washing to stop prematurely. (→Page 10)

## Flushing

Trouble	Please check
<b>For not flushing</b>	Are the main tap and the in-wall tank's shutoff valve fully open? (→Page 15) Has a power outage occurred? ▶ Press the button on the flush panel to flush the toilet. (→Page 53) Has a water failure occurred? ▶ Use a bucket to flush water. (→Page 53)
<b>The toilet does not flush even when the button of remote control is pressed</b>	Are you pressing the button repeatedly? ▶ After pressing the flush button, operation will not be accepted for about 10 to 20 seconds.
<b>The bowl unit does not clean automatically or timing is delayed (Auto flushing)</b>	Is "Auto flushing" set to "OFF"? ▶ Set to "ON". (→Page 31) Even if "Auto flushing" is set to "ON", it is not available in the following instances. <b>For about 60 seconds after the bowl unit flushes.</b> ▶ After about 60 seconds have passed, use the remote control to flush the bowl unit. (→Page 21) <b>When the time spent sitting on the toilet seat is less than about 6 seconds.</b> ▶ Use the remote control to flush the bowl unit. (→Page 21) <b>When the toilet is used in standing position.</b> ▶ The water flows after a maximum of about 20 seconds from when you leave the bathroom. ▶ If "Auto flush lid closed" is turned ON, 30 seconds after leaving the bathroom, the toilet seat and lid close and then the bowl unit flushes.

<b>The bowl unit does not clean automatically or timing is delayed (Auto flushing)</b>	When sitting on the toilet seat, is there a toilet seat cover or clothing on the seat sensor? Or are you sitting without touching the seat sensor? ▶ Check the location of the seat sensor and sit down so that it touches your skin directly. (→Page 10)
--	---

The timing for the "Auto flushing" can be changed. (→Page 32)

<b>The toilet flushes on its own</b>	Is "Auto flushing" set to "ON"? ▶ You can turn it "OFF". (→Page 31) Does the seat sensor have difficulty detecting? ▶ If you get up slightly from the seat or sit leftward on the seat, the seat sensor may not detect properly, causing the bowl unit to be flushed during use. (→Page 10) A light flush may be performed under the following conditions due to the bathroom layout, etc. • The toilet seat and lid are open and you stand in front of or walk past the front of the bowl unit. • "Auto open / close" is set to [SEAT/LID]. (→Page 36)
--------------------------------------	---

<b>Waste material does not flush down completely</b>	Are the main tap and the in-wall tank's shutoff valve fully open? (→Page 15) Is the water supply to the toilet disrupted by other running water fixtures? ▶ Cease using other fixtures and then flush the toilet. Are the flush and light flush buttons being used correctly? ▶ Full flush (for solid waste) : up to 33 ft (10 m) of toilet paper (single). ▶ Light flush (for liquid waste) : up to 10 ft (3 m) of toilet paper (single). Flushing may be difficult depending the consistency of the waste material. ▶ Flush the toilet again. If the bowl unit is not cleansed with a flushing, remove the stains with a brush or similar instrument. (→Page 48)
--	---

<b>A small amount of water flows into the bowl unit after the unit flushes</b>	If the water supply pressure drops significantly, for example if water is used elsewhere or if there is a water failure, water is supplied so that the water surface in the bowl unit rises to a certain level. <b>If the above symptom reappears</b> There may be a malfunction. ▶ Consult with TOTO customer service (→see contact information on the back cover)
--	--

<b>Some barium remains after flushing</b>	It may be difficult to flush down substances with a higher specific gravity than water, such as barium. ▶ Flush the toilet again. If the bowl unit is not cleansed by flushing, clean it with a cleaning sponge or brush. (→Page 48)
---	---

<b>There is residue on the bowl unit surface</b>	Oil and other hard-to-see grime may stick to the bowl unit surface. ▶ Clean with (non-abrasive) neutral toilet detergent. (→Page 48)
--	---

# Troubleshooting

## Toilet Seat and Toilet Lid (Auto open / close)

Trouble	Please check
<b>The toilet lid does not open automatically</b>	<p>Is "Auto open / close" set to "OFF"? ▶ Set to "ON". (→Page 34)</p> <p>Even if "Auto open / close" is set to "ON", it is not available in the following instances.</p> <ul style="list-style-type: none"> <li>Approximately 15 seconds since the toilet seat or toilet lid closed automatically</li> </ul> <p><b>When the toilet lid is closed with the remote control or by hand</b></p> <p>To make the product more user-friendly, a time interval is set from when the lid is closed to when it will open next.</p> <ul style="list-style-type: none"> <li>▶ Move away from the toilet and wait at least about 15 seconds before approaching the bowl unit again or open and close by hand. (→Page 21)</li> </ul> <p>Is "Auto open delay" set to [SET 2] or [SET 3]? (→Page 35)</p> <p>The toilet lid does not open automatically for about 20 seconds after the power is turned ON.</p> <ul style="list-style-type: none"> <li>▶ Use the remote control to open or close it. (→Page 21)</li> </ul> <p>Is a toilet lid or seat cover installed? ▶ Remove any covers. (→Page 9)</p> <p>If a function such as "Auto flushing" is operating, the body sensor may not detect properly. You can change the detection range of the body sensor. (→Page 45)</p>
<b>The toilet lid does not close automatically</b>	<p>Is "Auto open / close" set to "OFF"? ▶ Set to "ON". (→Page 34)</p> <p>In the following cases, the toilet lid closes in about 5 minutes.</p> <ul style="list-style-type: none"> <li>When you did not sit on the toilet seat</li> <li>When you sat on the toilet seat for less than 6 seconds</li> </ul>
<b>The toilet lid opens on its own</b>	<p>Because the body sensor can detect movement through the wall or door in front of the toilet, the "Auto open / close" function may cause the toilet lid to open automatically even when you are outside of the bathroom.</p> <ul style="list-style-type: none"> <li>▶ You can also set "Auto open / close" to "OFF". (→Page 34)</li> <li>▶ You can change the detection range of the body sensor. (→Page 45)</li> </ul> <p>Is a urinal or wash basin also installed in the bathroom? ▶ The body sensor may detect someone using the urinal, causing the toilet lid to open or close.</p> <p>The toilet lid opens before spraying aftermist for "Auto underseat CLEAN" or "Auto bowl CLEAN" and closes after completion.</p> <ul style="list-style-type: none"> <li>▶ You can select not to open the toilet lid when spraying mist. However, it may be less effective than when spraying mist after opening the toilet lid.</li> </ul> <p><b>How to configure the setting</b></p> <p>Press the "Opening and closing the toilet lid" button and "Water pressure adjustment -" button at the same time for 10 seconds or longer.</p> <p>The setting changes each time they are pressed and held for 10 seconds or longer.</p> <ul style="list-style-type: none"> <li>Spraying mist after opening the toilet lid: Short beep ↓↑</li> <li>Spraying mist without opening the toilet lid: Long beep &lt;Setting complete&gt;</li> </ul>
<b>The toilet lid closes on its own</b>	<p>Is "Auto open / close" set to "ON"? ▶ You can turn it "OFF". (→Page 34)</p> <p>Is "Auto close delay" set to [SET 1]? (→Page 34)</p> <p>When sitting on the toilet seat, is there a toilet seat cover or clothing on the seat sensor? Or are you sitting without touching the seat sensor? ▶ Check the location of the seat sensor and sit down so that it touches your skin directly. (→Page 10)</p>

## The toilet lid and toilet seat open at the same time

Is "Seat/lid" set to "Seat-lid"? (→Page 36)

## Stops (or closes) while opening

If the toilet lid or seat hits an obstruction the first time it opens after the power is turned ON, it may stop (or close) partway during the next operation.

- ▶ Eliminate any obstructions and turn the power OFF. Turn the power ON again after about 5 seconds. Then press the "Opening and closing the toilet lid" button on the remote control. (→Pages 15, 16, 21)

## The toilet lid does not close

When the toilet lid closes may differ according to which functions are used. (About 90 to 120 seconds)

## Cannot open or close with the remote control

**If it opens automatically.**  
▶ Check "Is the remote control working?" (→Page 58)

## Toilet Seat and Toilet Lid

Trouble	Please check
<b>The toilet seat is cold</b>	<p>Is the toilet seat temperature set to "OFF" or a low level? (→Page 25)</p> <p>Is energy saver in operation? The energy saver feature is on when the "Energy saver" LED is on and the "Power" LED is off on the main display. When you sit on the seat, the toilet seat heater is turned on temporarily and the seat is warmed in about 15 minutes. (→Page 28)</p> <ul style="list-style-type: none"> <li>▶ You can turn it "OFF" if the energy saver feature is "ON". (→Pages 30, 31)</li> </ul> <p>Have you been seated for a long time? After about 20 minutes of sitting, the temperature starts going down, and after about 1 hour, the toilet seat heater is turned "OFF". ▶ Stand up from the seat and then use again.</p> <p>Is a toilet lid or seat cover installed? ▶ Remove any covers. (→Page 9)</p>
<b>The toilet seat and lid close on their own and then the bowl unit flushes</b>	<p>Is "Auto flush lid closed" turned ON? (→Page 32)</p>

## Auto flush lid closed

Trouble	Please check
<b>"Auto flush lid closed" does not work</b>	<p>Is "Auto flush lid closed" turned OFF? ▶ Turn it ON. (→Page 32)</p> <p><b>If "Auto flush lid closed" is turned ON:</b> Check the "Auto flushing" and "Auto open / close" settings. (→Pages 31, 34) Even if "Auto flushing" is turned ON, "Auto flush lid closed" does not activate in the following cases.</p> <ul style="list-style-type: none"> <li><b>For about 60 seconds after the bowl unit flushes.</b> ▶ After about 60 seconds have passed, use the remote control to flush the bowl unit. (→Page 21)</li> <li><b>When the time spent sitting on the toilet seat is less than about 6 seconds.</b> ▶ Use the remote control to flush the bowl unit. (→Page 21)</li> <li><b>When the toilet is used in standing position.</b> ▶ About 30 seconds after you leave the bathroom, the toilet seat and lid close and then the bowl unit flushes.</li> </ul>

# Troubleshooting

## Auto flush lid closed (continue)

Trouble	Please check
<b>The toilet lid closes too early or too late</b>	You can change "Auto flush delay" to modify the length of time before closing the toilet lid. (SET 1 / SET 2 / SET 3) (→Page 32)

## Energy Saver

Trouble	Please check
<b>The Energy saver LED does not light up</b>	Has the power to the product been turned "OFF" or was there a power outage? The Energy saver LED on the main display may go off when the power is turned ON even if the energy saver feature is ON. It will turn on within about 24 hours since the setting is retained.
<b>The timer energy saver feature is not working</b>	Have the batteries in the remote control been replaced? "Timer energy saver" may be canceled when the batteries are replaced. ▶ Set the timer energy saver again at the time you want to start it. (→Page 31)
<b>The auto energy saver+ or auto energy saver feature is not working</b>	Because this function takes several days learning the usage conditions before starting energy saver, the amount of energy saving may be low, depending on the frequency of use. ▶ Check the energy saver setting. (→Pages 28, 29)

## Deodorizer

Trouble	Please check
<b>The deodorizer seems to be not working</b>	Is "Deodorizer" set to "OFF"? ▶ Set to "ON". (→Page 38)  <b>Even after sitting down, you do not hear operation sounds.</b> ▶ Sit so your skin is in direct contact with the seat sensor. (→Page 10) <b>If you hear an operation sound from the deodorizer, but odors are not removed.</b> ▶ Clean the deodorizing filter. (→Page 51)
<b>A strange odor is emitted</b>	Are you using an air freshener or deodorizer that you purchased separately? Doing so may reduce the effectiveness of the product's deodorizer or cause strange odors. ▶ Remove the air freshener or deodorizer.
<b>The auto power deodorizer feature is not working</b>	Is "Auto power deodorizer" set to "OFF"? ▶ Set to "ON". (→Page 38)  The auto power deodorizer starts about 10 seconds after you stand up from the toilet seat.

## Auto bowl CLEAN, Auto underseat CLEAN

Trouble	Please check
<b>The mist do not work</b>	Is "Auto bowl CLEAN" set to "OFF"? ▶ Set to "ON". (→Page 37)  The following functions do not work when the toilet seat is open. Is "Seat/lid" of "Auto open / close" set to "Seat+lid"? ▶ You can change it to "Lid". (→Page 36)  If you use the pre-mist or after-mist immediately after the previous user leaves the bathroom, it may not be activated.  If "Auto bowl CLEAN" is turned OFF, mist is not sprayed for "Auto underseat CLEAN", either. ▶ Turn "Auto bowl CLEAN" ON. (→Page 37)
<b>Mist is not sprayed to the entire back of the toilet seat</b>	"Auto underseat CLEAN" and "Manual spray" spray mist underneath the front of the toilet seat that urine tends to splash on.
<b>The pre-mist sprays out spontaneously</b>	Because the body sensor can detect movement through the wall or door in front of the toilet, the "Auto bowl CLEAN" function may cause the toilet to pre-mist even when you are outside of the bathroom. ▶ You can also set "Auto bowl CLEAN" to "OFF". (→Page 37)  If the washing functions (e.g.,Rear washing and Front washing) are not used for about 8 hours, "Auto bowl CLEAN" starts and mist is sprayed inside the bowl unit.

## Lights

Trouble	Please check
<b>The soft light, bowl light and CLEAN indicator do not light up</b>	Is the "Soft light", "Bowl light", or "CLEAN indicator" turned OFF? ▶ Set to "ON". (→Pages 40, 41)
<b>The soft light lights permanently</b>	Is "Night light" ("Night mode") turned ON? ▶ If it is turned ON, the Soft light lights permanently. You can also turn it OFF [STANDBY]. (→Page 39)
<b>"Night light" (Night mode) is not activated</b>	Have the batteries in the remote control been replaced? "Night light" (Night mode) may be canceled when the batteries are replaced. ▶ Set them again. (→Page 39)
<b>The Clean Light illuminates the inside of the toilet bowl.*1</b>	When "Full flush", "Rear washing", or "Rear soft washing" have not been used in about 10 hours the Clean Light lights up.
<b>The Clean Light does not light up*1</b>	The Clean Light does not light up in the following cases: • When the toilet lid is open (when "Auto open / close" is "OFF," etc.). • When "Full flush", "Rear washing", or "Rear soft washing" were not used for solid waste or liquid waste.

\*1 Other than the SN9538M.



# Troubleshooting

## Others

Trouble	Please check
<b>Water is leaking from the plumbing connections</b>	If any nuts in a connection are loose, firmly tighten them with a tool such as a monkey wrench. ▶ If the water leak does not stop, close the shutoff valve and consult with TOTO customer service. (→see contact information on the back cover)
<b>The display on the remote control goes out</b>	The display goes out when no button on the remote control is pressed for about 60 seconds or more.
<b>Water splashes up when using the toilet</b>	The water in the bowl unit that is used to mask the smell of excrement is the cause of the splashing. ▶ Adding a layer of toilet paper on the surface of the water can slightly dampen splashing.
<b>When flushing, you hear a squishing sound underneath the floor</b>	There are cases when the sound is made inside the discharge pipe because of the device to ensure water in the bowl unit after the unit flushes.
<b>When flushing, you hear a gurgling sound</b>	When the toilet is flushed together with waste material, the sound is a result of air, waste material and water being pulled through the system.
<b>There are black stain on or around the bowl unit</b>	Ammonia in urine may cause black stains. ▶ If urine has splashed on the bowl unit or floor, wipe it immediately.
<b>There is black or pink slime on the bowl unit surface</b>	It is a result of growth of airborne fungal spores or bacteria that feed on filth on the bowl unit. ▶ Clean with (non-abrasive) neutral toilet detergent.
<b>There are water droplets on the bowl unit surface</b>	Condensation occurs when the humidity is high, and there is a significant difference between water and room temperatures. ▶ Wipe off droplets with dry cloth. (Condensation can build up on condensation-proof bowls when the difference between room and water temperatures exceeds 59°F (15°C) and the ambient humidity reaches 80%.)
<b>The top unit makes a sound</b>	<p><b>When entering the bathroom</b> If "Auto bowl CLEAN" is "ON", you may hear that pre-mist is spraying mist in the bowl unit to make it more difficult for dirt to adhere. ▶ You can turn it "OFF". (→Page 37)</p> <p><b>When using the washing functions (Rear washing, Rear soft washing, or Front washing)</b> You can hear the sound of the pump operating while washing water is being supplied.</p> <p><b>When moving away from the bowl unit after use</b> If "Auto wand CLEAN" is "ON" and you use the washing functions (e.g.,Rear washing and Front washing), you may hear that the wand is extended and cleaned with "EWATER+." ▶ You can turn it "OFF". (→Page 36)</p> <p>If "Auto bowl CLEAN" is "ON" and you sit on the toilet seat and use the toilet, you may hear that mist of "EWATER+" is sprayed inside the bowl unit. (When you move away) ▶ You can turn it "OFF". (→Page 37)</p> <p>You may hear that the wand is extended and the remaining water in the product is drained after "Auto wand CLEAN" and other functions are performed.</p> <p>When "Auto power deodorizer" is "ON", operation sounds are made while the deodorizing power increases for 60 seconds after you stand up from the toilet seat. ▶ You can turn it "OFF". (→Page 38)</p>

## The top unit makes a sound

### When not using the product (e.g., at night)

You may hear the following sounds if "Auto wand CLEAN" or "Auto bowl CLEAN" is "ON" and if you do not use the washing functions (e.g.,Rear washing and Front washing) for about 8 hours.

"Auto wand CLEAN" : Sound of cleaning the wand with "EWATER+".

: Sound of extending the wand and draining remaining water from the product after operation of functions.

"Auto bowl CLEAN" : Sound and operating noise of spraying EWATER+ mist on the bowl unit.

▶ You can turn it "OFF". (→Pages 36, 37)

Because the body sensor can detect movement through the wall or door in front of the toilet, the "Auto open / close" and "Auto bowl CLEAN" functions may cause the toilet to pre-mist, or the lid to open, even when you are outside of the bathroom.

▶ You can also set "Auto open / close" or "Auto bowl CLEAN" to "OFF".

(→Pages 34, 37)

▶ You can change the detection range of the body sensor. (→Page 45)

Operating noise may occur for extending the wand to prevent damage due to freezing by discharging the water remaining within the product.

## The toilet bowl surface repels water or tends to get dirty easily\*1

The toilet bowl surface needs to be cleaned.

▶ Clean with a toilet brush or the like using commercially available hydrochloric acid-based or inorganic acid-based detergent.

For daily cleaning, use neutral detergent.

Is "Auto open / close" set to "OFF"?

▶ If it is set to "OFF", Clean Light does not work while the lid is open.

\*1 Other than the SN9538M.



# Specifications

Item	SN9548MX	SN9538M
Rated power supply	AC 120 V, 60 Hz	
Rated power consumption	1294 W	
Maximum power consumption	1452 W	
Type of water heater	Instantaneous type	
Power cord length	1.6 ft (0.5 m)	
Water protection level	IPX4	
Bowl unit		
Flush volume	Full 1.2 gal (4.5 L), Light 0.8 gal (3.0 L)	
Water supply system	Concealed tank system	
Flush type	TORNADO FLUSH	
Bowl style	Elongated	
Top unit		
Washing		
Spray volume <sup>*1</sup>	Rear washing: Approx. 0.08 - 0.11 gal/min (Approx. 0.32 - 0.43 L/min) Rear soft washing: Approx. 0.08 - 0.11 gal/min (Approx. 0.32 - 0.43 L/min) Front washing: Approx. 0.08 - 0.11 gal/min (Approx. 0.29 - 0.43 L/min) Wide front washing: Approx. 0.09 - 0.11 gal/min (Approx. 0.35 - 0.43 L/min)	
Water temperature	Adjustable temperature range: OFF, about 86 - 104 °F (about 30 - 40 °C)	
Heater capacity	1116 W	
Safety device	Temperature fuse	
Backflow prevention device	Vacuum breaker, Check valve	
Heated seat		
Surface temperature	Adjustable temperature range: OFF, about 82 - 97 °F (about 28 - 36 °C) (Auto energy saver: about 79 °F (about 26 °C), Auto energy saver+: OFF)	
Heater capacity	59 W	
Safety device	Temperature fuse	
Deodorizer		
Method	O <sub>2</sub> deodorization	
Airflow volume	Normal mode: Approx. 3.17 ft <sup>3</sup> /min (Approx. 0.09 m <sup>3</sup> /min) Power mode: Approx. 5.65 ft <sup>3</sup> /min (Approx. 0.16 m <sup>3</sup> /min)	
Power consumption	Normal mode: Approx. 1.6 W, Power mode: Approx. 4.0 W	
Warm air dryer		
Warm air temperature <sup>*2</sup>	Adjustable temperature range: about 95 - 140 °F (about 35 - 60 °C)	
Airflow volume	Approx. 8.83 ft <sup>3</sup> /min (Approx. 0.25 m <sup>3</sup> /min)	
Heater capacity	258 W	
Safety device	Temperature fuse	
Water supply pressure	Minimum required water pressure: 7.25 PSI (0.05 MPa) <Dynamic> Maximum water pressure: 108.75 PSI (0.75 MPa) <Static>	
Water supply temperature	32 - 95 °F (0 - 35 °C)	
Working ambient temperature	32 - 104 °F (0 - 40 °C)	
Dimensions	W 1.47 x D 2.21 x H 1.47 ft (W 449 x D 675 x H 447 mm)	
Weight	About 101 lb (about 46 kg) <Top unit about 22 lb (about 10 kg), Bowl unit about 79 lb (about 36 kg)>	

When disposing of this product, please follow your local or state guidelines for proper disposal.

\*1 At 29 PSI (0.20 MPa) (dynamic) water pressure

\*2 Temperature around the warm air outlet measured by TOTO.

# Limited Warranty

## Three Years Limited Warranty

1. TOTO warrants its product to be free from defects in materials and workmanship during normal use when properly installed and serviced, for a period of three (3) years from date of purchase. This limited warranty is extended only to the ORIGINAL PURCHASER of the Product and is not transferable to any third party, including but not limited to any subsequent purchaser or owner of the Product.

This warranty applies only to TOTO Product is purchased and installed in USA and Canada.

2. TOTO's obligations under this warranty are limited to repair, replacement or other appropriate adjustment, at TOTO's option, of the Product or parts found to be defective in normal use, provided that such Product was properly installed, used and serviced in accordance with instructions.

TOTO reserves the right to make such inspections as may be necessary in order to determine the cause of the defect.

TOTO will not charge for labor or parts in connection with warranty repairs or replacements. TOTO is not responsible for the cost of removal, return and/or reinstallation of the Product.

3. This warranty does not apply to the following items:

- Damage or loss sustained in a natural calamity such as fire, earthquake, flood, thunder, electrical storm, etc.
- Damage or loss resulting from any accident, unreasonable use, misuse, abuse, negligence, improper care, or maintenance of the Product.
- Damage or loss resulting from sediments or foreign matter contained in a water system.
- Damage or loss resulting from the quality of water in the region where the product is used.
- Damage or loss resulting from improper installation or from installation of the Product in a harsh and/or hazardous environment, or improper removal, repair or modification of the Product. This includes locations where the water pressure is above local codes or standards. (NOTE : Product model codes allow a maximum of 80 PSI. Check local codes or standards for requirements).
- Damage or loss resulting from electrical surges or lightning strikes or other acts which are not the fault of TOTO or which the Product is not specified to tolerate, including failure to use the factory equipped cord and plug or use of a loose or faulty electrical outlet or use of a current or socket other than a 120 V, 60 Hz electrical current from a GFI (ground, fused) socket.
- Damage or loss resulting from normal and customary wear and tear, such as gloss reduction, scratching or fading over time due to use, cleaning practices or water or atmospheric conditions, including but not limited to, the use of bleach, alkali, acid cleaners, dry (powder) cleaners or any other abrasive cleaners or the use of metal or nylon scrubbers.

4. If the Danger Label which has been placed over the seams on the back of the Product's top unit is broken or otherwise not intact, this limited warranty is void.

5. In order for this limited warranty to be valid, proof of purchase is required. TOTO encourages warranty registration upon purchase to create a record of Product ownership at <http://www.totousa.com>. Product registration is completely voluntary and failure to register will not diminish your limited warranty rights.

6. If the Product is used commercially or is installed outside of USA or Canada. TOTO warrants the Product to be free from defects in materials and workmanship during normal use for three (3) years from the date of installation of the Product, and all other terms of this warranty shall be applicable except the duration of the warranty.

7. This warranty gives you specific legal rights. You may have other rights which vary from state to state, province to province or country to country.

8. To obtain warranty repair service under this warranty, you must take the Product or deliver it prepaid to a TOTO service facility together with proof of purchase (original sales receipt) and a letter stating the problem, or contact a TOTO distributor or products service contractor, or write directly to TOTO U.S.A., INC., 1155 Southern Road, Morrow, GA 30260 (888) 295 - 8134 or (678) 466-1300, if outside the U.S.A. If, because of the size of the Product or nature of the defect, the Product cannot be returned to TOTO, receipt by TOTO of written notice of the defect together with proof of purchase (original sales receipt) shall constitute delivery. In such case, TOTO may choose to repair the Product at the purchaser's location or pay to transport the Product to a service facility.

WARNING! TOTO shall not be responsible or liable for any failure of, or damage to, this Product caused by either chloramines in the treatment of public water supply or cleaners containing chlorine (calcium hypochlorite).

NOTE: The use of a high concentrate chlorine or chlorine related product's can seriously damage the fittings. This damage can cause leakage and serious property damage.

# Limited Warranty

THIS WRITTEN WARRANTY IS THE ONLY WARRANTY MADE BY TOTO. REPAIR, REPLACEMENT OR OTHER APPROPRIATE ADJUSTMENT AS PROVIDED UNDER THIS WARRANTY SHALL BE THE EXCLUSIVE REMEDY AVAILABLE TO THE ORIGINAL PURCHASER. TOTO SHALL NOT BE RESPONSIBLE FOR LOSS OF THE PRODUCT OR FOR OTHER INCIDENTAL, SPECIAL OR CONSEQUENTIAL DAMAGES OR EXPENSES INCURRED BY THE ORIGINAL PURCHASER, OR FOR LABOR OR OTHER COSTS DUE TO INSTALLATION OR REMOVAL, OR COSTS OF REPAIRS BY OTHERS, OR FOR ANY OTHER EXPENSE NOT SPECIFICALLY STATED ABOVE. IN NO EVENT WILL TOTO'S RESPONSIBILITY EXCEED THE PURCHASE PRICE OF THE PRODUCT. EXCEPT TO THE EXTENT PROHIBITED BY APPLICABLE LAW, ANY IMPLIED WARRANTIES, INCLUDING THAT OF MERCHANTABILITY OR FITNESS FOR USE OR FOR A PARTICULAR PURPOSE, ARE EXPRESSLY DISCLAIMED. SOME STATES DO NOT ALLOW LIMITATIONS ON HOW LONG AN IMPLIED WARRANTY LASTS, OR THE EXCLUSION OR LIMITATION OF INCIDENTAL OR CONSEQUENTIAL DAMAGES, SO THE ABOVE LIMITATION AND EXCLUSION MAY NOT APPLY TO YOU.

# MEMO