









WASHLET® G5A Lite Integrated Smart Toilet - 1.2 GPF / 1.0 GPF

FEATURES

- Compact, modern one-piece skirted Smart Bidet Toilet with integrated personal cleansing and comfort features
- CEFIONTECT® ceramic glaze minimizes waste from sticking to porous ceramic surfaces
- High-efficiency TORNADO FLUSH® system - 1.2 GPF / 1.0 GPF (4.5 LPF / 3.8 LPF)
- Auto flush - with back-up manual flush for power outages
- Universal Height, ADA compliant
- Touchless auto open/close lid
- EWATER+® auto-cleans wand after every use
- PREMIST® automatically mists the bowl before each use
- Self-cleaning wand cleans itself inside and out before and after every use
- CLEAN RESIN® keeps wand and seat cleaner, more hygienic, and effortless to maintain
- Gentle aerated, warm water, front and rear spray with oscillating and pulsating features
- Adjustable spray position, water temperature, and water pressure
- Instantaneous water heater for continuous warm water and energy savings
- Warm air dryer with three variable temperature settings
- Automatic air deodorizer
- Multifunction remote control with personalized memory settings for up to 4 users
- Heated seat with temperature control
- Seamless seat design eliminates the gap where dirt collects
- CLEAN LIFT allows easy cleaning between the top and bowl unit
- Automatic and programmable energy saving systems



- | | |
|---|---|
|  WASHLET |  PREMIST |
|  TORNADO FLUSH |  AUTO FLUSH |
|  EWATER |  UNIVERSAL HEIGHT |
|  CEFIONTECT |  SKIRTED DESIGN |

PRODUCT SPECIFICATION

The WASHLET G5A Lite with the TORNADO FLUSH system toilet shall be 1.2 GPF / 1.0 GPF (4.5 LPF / 3.8 LPF). Toilet shall have CEFIONTECT ceramic glaze. Toilet shall be of skirted design, elongated front bowl with auto open and close seat. Toilet shall be TOTO Model MS7421CEMFG#01.

COMPONENTS

- SN7421M - Top Unit
- CT7631CEMFG - Elongated Bowl Unit

COLOR/FINISHES

- #01 Cotton

CODES/STANDARDS

- Meets and exceeds ASME A112.4.2, ASME A112.19.2/ CSA B45.1, ASME A112.18.1/CSA B125.1, UL 1431, CSA C22.2 # 68 and back siphonage testing to ASSE 1001 and CSA B64.1.1
- Certifications: IAPMO(cUPC), State of Massachusetts, City of Los Angeles and others
- Code Compliance: UPC, IPC, NSPC, and others
- ADA Compliant
- Complies with CA Prop 65 warning requirements



MS7421CEMFG

WASHLET® G5A Lite Integrated Smart Toilet - 1.2 GPF / 1.0 GPF

SPECIFICATIONS

Water Use	1.2 GPF / 1.0 GPF (4.5 LPF / 3.8 LPF)
Flush System	TORNADO FLUSH®
Water Pressure	Min: 7.25 PSI (0.05MPa) Flowing Max: 108.75 PSI (0.75MPa) Static
Water Surface	8-5/8" x 7-1/4"
Trap Diameter	2" (51 mm)
Rough-in	12"
Trap Seal	2-1/8" (54 mm)
Warranty	One Year Limited
Material	Bowl: Vitreous China Seat + Cover: Plastic
Power Rating	AC 120 V, 60 Hz, 1276 W
Power Cord Length	3.9ft (1.2m)
Rear Washing	Approx. 0.07- 0.11 gal/min
Rear Soft Washing	Approx. 0.07- 0.11 gal/min
Front Washing	Approx. 0.08 - 0.11 gal/min
Washing Spray Temperature	95°F - 104°F (35°C - 40°C)
Safety Feature	Temperature Fuse
Drying Feature	Air Temperature: 95°F - 140°F (35°C - 60°C)
Dryer Safety Feature	Temperature Fuse
Seat Warming Feature	Surface Temperature: Approx. 82°F - 97°F (28°C - 36°C)
Seat Heater Capacity	50 W
Seat Safety Feature	Temperature Fuse
Air Purifying Feature	O2 Deodorizer
Ambient Temperature Range	32°F - 104°F (0°C - 40°C)
Shipping Weight	SN7421M: 18 lbs CT7631CEMFG: 81 lbs
Shipping Dimensions	SN7421M: 31-3/16" L x 17-1/2" W x 10-3/4" H CT7631CEMFG: 31-5/8" L x 15-3/4" W x 22-5/8" H

INSTALLATION NOTES

- For use with potable water only. Do not use with recycled water.
- Warning: If there is a base board in the restroom, the center of the floor drain should be a minimum of 12" from the base board.
- It is highly recommended to use a surge protector to prevent damage in the event of a power surge.
- The following factors may affect IR signal strength and top unit operation: product and remote control location, room size, shape, construction materials, and degree of darkness (color) of ceiling and walls.
- Consult local electric code for GFCI location and installation requirements.
- This product is designed and evaluated based on the laws and technical standards of the Territory. Use outside the Territory may compromise safety and performance or violate local laws. Warranty, repairs, and technical support are not available for use outside the Territory.

DIMENSIONS

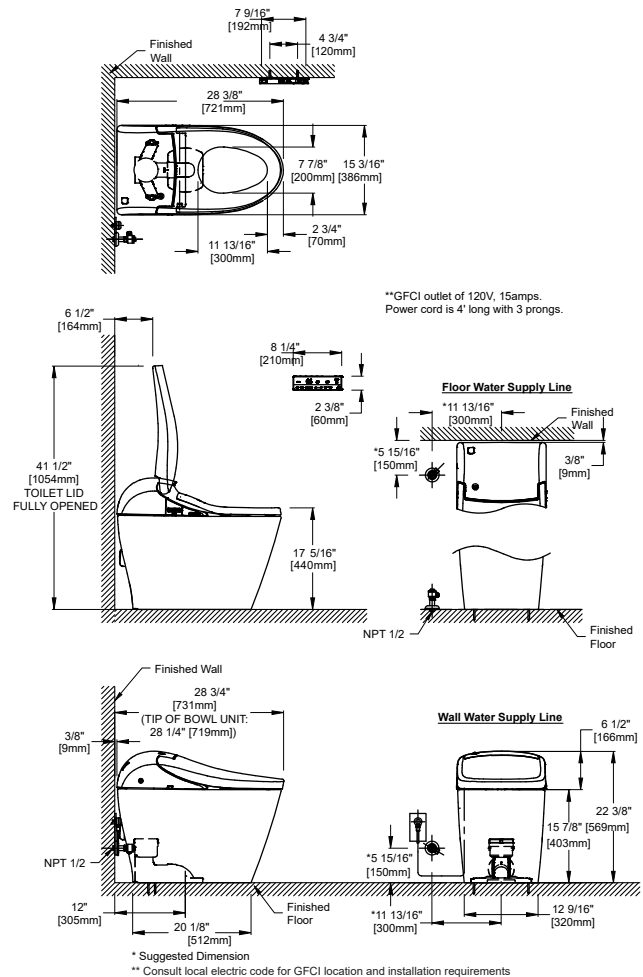

TOTO®

These dimensions and specifications are subject to change without notice